

## NOTES ON THIS MANUAL

Keep these instructions with your computer at all times. The proper set up, use and care can help extend the life of your computer. In the event that you transfer ownership of this computer, please provide these instructions to the new owner.

This manual is divided into sections to help you find the information you require. Along with the **Table of Contents**, an **Index** has been provided to help you locate information.

In addition, many application programs include extensive help functions. As a general rule, you can access help functions by pressing F1 on the keyboard. These help functions are available to you when you use the Microsoft Windows<sup>®</sup> operating system or the various application programs.

We strongly recommend that you read the Online Manual for your Notebook, which can be found in the **Start Menu**.

⇒ **Important:** Additional information about your notebook can be found in the online help in the Start Menu of your notebook. Click on:



Information about your notebook

This interactive manual is designed to provide additional information about your Notebook as well as useful links accessible via the World Wide Web.

Windows<sup>xp</sup> invites you to a **tour** (notes on the task bar) to familiarize yourself with the operating system. We listed further useful sources of information starting on page 55.

## AUDIENCE

These instructions are intended for both the novice and advanced user. Regardless of the possible professional utilization, this Notebook is designed for day-to-day household use. The functions and applications for use with this Notebook have been designed with the entire family in mind.

## DOCUMENT YOUR NOTEBOOK

It is important to document the details of your Notebook purchase in the event you need warranty service. The serial number can be found on the back of the Notebook:

Serial Number .....  
Date of Purchase .....  
Place of Purchase .....

## QUALITY

We have selected the components in this computer for their high level of functionality, ease of use, safety and reliability.

Through balanced hardware and software design we are able to provide you with an innovative personal computer useful for applications relating to both work and leisure.

We are pleased to welcome you as our newest customer.

Copyright© 2005 Medion®. All rights reserved. Microsoft®, MS-DOS®, and Windows are registered trademarks of Microsoft Corporation in the U.S. and other countries. Pentium® is a registered trademark of Intel Corporation. The names of actual companies and products mentioned herein may be the trademarks of their respective owners.

This product incorporates copyright protection technology that is protected by method claims of certain U.S. patents and other intellectual property rights owned by Macrovision Corporation and other rights owners. Use of this copyright protection technology must be authorised by Macrovision Corporation, and is intended for home and other limited viewing uses only unless otherwise authorized by Macrovision Corporation. Reverse engineering or disassembly is prohibited.

**Information in this document is subject to change without notice.**

**Table of Contents:**

**SAFETY AND MAINTENANCE..... 1**

- Safety Instructions ..... 3
- Data Security..... 4
- Set-Up Location ..... 5
- Ambient Temperature ..... 5
- Power Adapter ..... 6
  - Power supply ..... 6
  - Cabling ..... 6
- Modem ..... 7
- Information about the regulatory compliance of wireless LAN ..... 7
- Touch Pad ..... 7
- Battery Operation ..... 8

**VIEWS & HANDLING..... 9**

- Views ..... 11
  - Included with Your Notebook..... 11
  - Open Notebook ..... 12
  - Front View ..... 13
  - Left Side ..... 13
  - Right Side ..... 13
  - Rear Side ..... 14
  - Device Indicators..... 14
- Getting Started ..... 16
  - Short description of the Windows® Desktop ..... 19
  - Working in Comfort..... 21

**MAIN COMPONENTS ..... 23**

- Power Supply..... 25
  - On/Off Button ..... 25
  - Power Adapter ..... 26
  - Battery Operation..... 27
    - Inserting the Battery..... 27
    - Removing the battery..... 27
    - Charging the Battery ..... 28
    - Discharging the battery ..... 28
    - Battery Power ..... 29
- Power Management ..... 30
  - Standby Mode..... 30
  - Suspend (hibernate) Mode..... 30

Display .....	31
Opening and Closing the Display.....	31
Screen Resolution.....	32
Connecting an External Monitor .....	33
Connecting a TV.....	35
Data Entry .....	36
The Keyboard .....	36
Notebook-Specific Key Combinations.....	36
Touch Pad .....	37
The Hard drive.....	38
Important Directories.....	39
The Optical Drive.....	40
Loading a Disc .....	40
Playing Back and Retrieving Data from Discs .....	41
Emergency Ejection of a Blocked Disc.....	42
Regional Playback Information for DVD.....	43
Subjects Concerning the CD/DVD-Rewriter.....	44
Recordable/Rewriteable Discs.....	44
The Sound Card .....	45
External Audio Ports .....	45
Modem .....	47
What is a Modem? .....	47
Modem Port.....	48
The Network.....	49
What is a network?.....	49
Fast Ethernet-Network .....	49
Troubleshooting within the Network .....	50
Wireless LAN.....	51
The PC Card Slot.....	52
Installing a PC Card .....	52
Removing a PC Card .....	52
Universal Serial Bus (USB) Port .....	53
IEEE 1394 (FireWire®) .....	54
Application Options for IEEE1394 .....	54
Technical Specifications.....	54
Software .....	55
Getting to Know Windows XP .....	55
Windows® XP Manual .....	55
Windows® XP Help and Support .....	55
Microsoft® Interactive Training .....	56

Installation of Software .....	57
Software Deinstallation.....	59
Windows Activation.....	59
The BIOS Set-up-Program .....	60
Running the BIOS Set-up.....	60
Navigating the BIOS Utility .....	60
<b>FIRST AID .....</b>	<b>61</b>
FAQ – Frequently Asked Questions.....	63
Data and System Security .....	65
Data Security.....	65
Maintenance Programs .....	65
Password Reset Disk .....	65
Windows® Update.....	66
Windows Update Information for Data Security .....	67
System Recovery .....	68
Correction .....	68
System Restore powered by Symantec .....	69
Limits of the Recovery.....	70
Performing the Restore.....	70
Troubleshooting .....	71
Localize the Cause.....	71
Check Cables and Connections .....	71
The Power On Self Test (POST).....	71
Errors And Possible Causes .....	72
Additional Support.....	73
Driver Support .....	73
Maintenance .....	74
Care of the TFT Display .....	74
Transporting the Notebook.....	75
Recycling and Disposal .....	76
Batteries and Proper Treatment.....	77
Securing your Notebook .....	78
Setting a User Password .....	78
Using a safety lock.....	78
Upgrades and Repairs .....	79
Notes for Service Engineers .....	79

<b>APPENDIX .....</b>	<b>81</b>
Standards .....	83
Electromagnetic Compatibility .....	83
ISO 13406-2 Class II .....	83
FCC Compliance Statement .....	85
Warranty .....	86
Liability limitations.....	87
Copying this manual .....	87
Index .....	89



Device ██████

At the end of its life, the appliance must not be disposed of in household rubbish. Enquire about the options for environmentally-friendly disposal



Batteries

Do not dispose of used batteries in the household rubbish! They must be deposited at a collection point for used batteries.

## Safety and Maintenance

<b>Subject</b>	<b>Page</b>
Data Security.....	4
Set-up Location.....	5
Ambient Temperature .....	5
Power Adapter .....	6
Modem .....	7
Wireless LAN .....	7
Touch Pad .....	7
Battery Operation.....	8



# SAFETY INSTRUCTIONS

---

Please follow the instructions in this section for the safe operation of your notebook:

- ☞ **Do not** allow small children to play unattended with electrical equipment. Children are incapable of judging potential risks properly.
- ☞ **Do not** open the case of the notebook, the battery or the power adaptor. When the case is open there is a danger of severe electric shock.
- ☞ CD-ROM-/CDRW-/DVD-drives are **Laser Class 1** devices. These lasers **must** remain in their sealed casing. **DO NOT** remove the drive covers, as exposure to the lasers may be harmful.
- ☞ **Do not** insert objects through the slots and openings of the notebook. This may lead to electric shock, electrical short-circuit or fire that will damage your notebook.
- ☞ Slots and openings in the notebook serve to ventilate it. **Do not cover up these openings**, because the notebook could overheat otherwise.
- ☞ The notebook **is not** intended to be operated in a **heavy industry company**. Operation under extreme environmental conditions can result in damage to your notebook.
- ☞ **Do not** operate the notebook **during a thunderstorm**, in order to avoid damage through lightning strike.
- ☞ **Do not** cover the slots and openings of the notebook. **Never** place objects on top of the notebook that would exert any pressure on the display. There is a danger that even slight pressure may break the TFT display.

- ☞ There is a risk of injury if the **TFT display breaks**. Use **protective gloves** to pack up the broken pieces and contact customer service to arrange for proper disposal. It is important to thoroughly wash your hands after handling a broken TFT display. There is a chance that **chemicals** may have been released.
- ☞ To avoid damage to the TFT Display, **never** open it a **full 120°**. **Do not** forcibly open it.
- ☞ In order to avoid damage to the display, **do not** touch it with your fingers or sharp objects.
- ☞ **Never** lift the notebook by the TFT Display; doing so could break the hinges.

**Switch off your PC immediately** or do not switch it on at all and contact customer service ...

- ... if the power cord or the connectors attached to it are burnt or damaged. Replace the defective power cord with an original power cord. Under no circumstances may a defective power cord be repaired.
- ... if the **housing** of the PC is **damaged** or **fluids have leaked into it**.  
Have the PC checked by customer service first, because the PC may not be safely operated otherwise and there may be a life-threatening risk of electrocution!

## DATA SECURITY



Every time you update your data make back-up copies on an external storage medium. The supplier does not assume liability for data loss or damage to data storage units, and no claims can be accepted for damages resulting from the loss of data or consequential losses.

## SET-UP LOCATION

- Keep your notebook and all connected peripherals away from **moisture, dust, heat** and direct **sunlight**. Failure to do so can lead to Notebook malfunction or damage.
- It is highly recommended you **do not use the** notebook **outdoors**.
- Operate the notebook and all peripherals on **a stable, balanced and vibration-free surface**.
- **Do not** leave the base of your notebook on your lap or any part of your body for a long period of time. The notebook can become very warm while it is turned on or charging and can cause discomfort or injury from heat exposure.

## AMBIENT TEMPERATURE

- The notebook is most reliably operated at an ambient temperature between **+41°** and **+104° F** and at a relative humidity between **20%** and **70%** (without condensation).
- When powered off, the notebook can be stored at temperatures between **32°** and **140° F**.

## POWER ADAPTER

Pay attention to the following information, in order to connect your notebook correctly:

### POWER SUPPLY

- ☞ Do not open the power adapter housing. When the housing is open there is a **danger** of severe electric shock. It contains no user-serviceable parts.
- ☞ The electric outlet must be in the vicinity of the notebook and within reach of the power adapter cables.
- ☞ To disconnect your notebook from the power source, or set the notebook to battery operation, remove the power cord from the notebook's power socket.
- ☞ Only use the notebook with a power adaptor operating at **AC 115V~/60 Hz**. In European countries use the notebook at **AC 220-240V~/50 Hz**.  
For details on power consumption, please refer to the rating plate on the rear of your notebook. If you are unsure of the type of power supply available at the point of use, ask your local power company.
- ☞ Use **only** the supplied power cord and power adapter.
- ☞ If using an extension cord, make certain that it meets your local safety requirements. If in doubt, consult an electrician.
- ☞ To provide additional protection against electric shock, power surges, lightning strikes, or other electrical damage to your notebook, we recommend the use of a **surge protector**.
- ☞ **Firstly** remove the **plug**, and then the connector of the notebook, **from the power source**, if you want to detach the network adapter from the mains power supply. A reverse sequence could damage the network adapter or the notebook. Always hold the connector firmly when removing it. **Never pull on the power cord**.

### CABLING

- ☞ Arrange cables so no one can walk on or trip over them.
- ☞ **Do not** place objects on any of the cables.

## MODEM

- ☞ If your system has a modem, please make sure you connect it to an **analogue** telephone line only. Connecting to a digital PBX, a digital line designed for broadband services or ISDN, a shared service line or a payphone will damage the modem or the devices to which it is connected.

This notebook, if equipped with a modem, has been tested according and complies with the European regulatory guidelines for radio equipment and telecommunication installations (R&TTE 1999/5/EG).

The modem meets the requirements of TBR21 (01/1998) and EG201120/V1.1.1/01/98 regarding connection with an analog telephone network.

## INFORMATION ABOUT THE REGULATORY COMPLIANCE OF WIRELESS LAN

The following low power radio equipment, which has separately been tested and approved according R&TTE guideline (1999/5/EC), is bundled with this PC:

-Wireless Lan

These radio devices are marked individually with the CE mark.

## TOUCH PAD

Light pressure with the tip of your finger is all that is required to operate the touch pad. Because the touch pad is electrostatic sensitive, objects cannot be used in place of your fingers. Using a pen or other object can damage the touch pad or cause the notebook to malfunction.

## BATTERY OPERATION

To extend the life and power of your battery and guarantee secure operation, the instructions below should be followed:

- ☞ Never expose the battery to **direct sunlight** or **heat** for long periods.
- ☞ **Do not** dispose of the battery by fire.
- ☞ Disregarding these instructions will lead to damage and under some circumstances may even cause the battery to **explode**.
- ☞ **Do not** open the battery housing; it contains no user-serviceable parts.
- ☞ Keep the battery away from electrically conductive materials, chemical substances and cleaning agents.
- ☞ Only use the originally supplied power adapter to charge the battery.
- ☞ Ensure (through the display or the signalling sound of the notebook) that the battery is **completely discharged** before recharging it.
- ☞ Replace the battery **only** with the same type or an equivalent type recommended by the manufacturer.
- ☞ Charge the battery only until the battery charging light goes out. Also, refer to the instructions under "Charging the Battery" on page 28 for instructions on checking the battery level.
- ☞ Only change the battery when the unit is switched off.
- ☞ **Batteries are classified as special waste** and should always be disposed of properly. Contact Customer Service for more details.

## Views & Handling

<b>Subject</b>	<b>Page</b>
Included with your notebook .....	11
Open notebook .....	12
Front view .....	13
Left Side .....	13
Right Side .....	13
Rear Side .....	14
Power and Status Indicators .....	14
Getting started.....	16
Working in comfort.....	21







## INCLUDED WITH YOUR NOTEBOOK

Please check that the contents are complete and notify us within 14 days of purchase if any of the following components are missing:

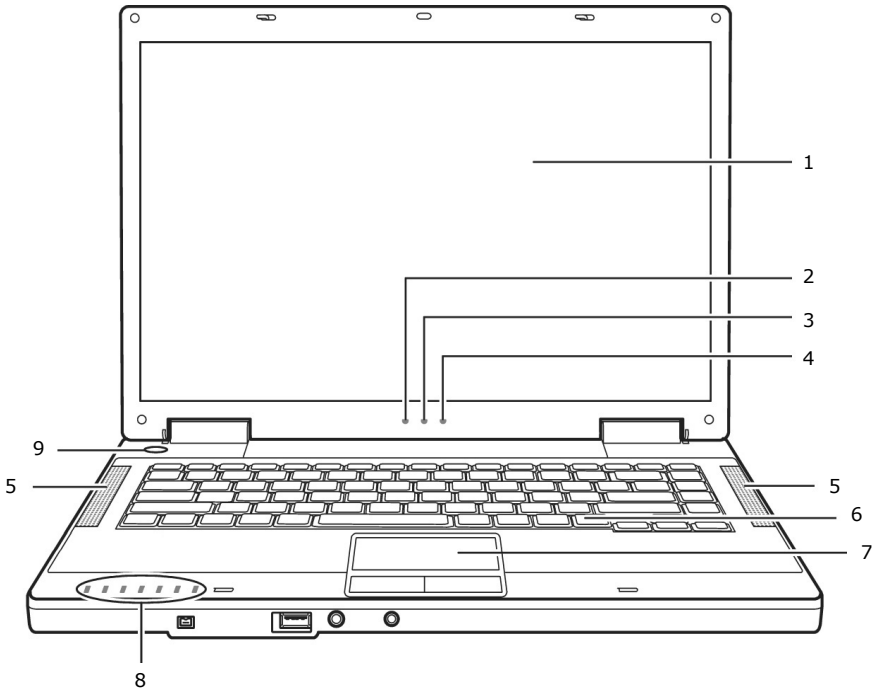
Notebook
Battery
Power adapter with connection cable (Model: <b>FSP065-AAC</b> )
Modem cable
Application-/Support-Disc
Microsoft Windows® XP Recovery Disc + manual
User manual
Warranty card

# OPEN NOTEBOOK



- 1** - TFT display ..... (⇒ p. 31)
- 2** - Battery power indicator  ..... (⇒ p. 14)
- 3** - Battery charge indicator  ..... (⇒ p. 14)
- 4** - AC power indicator  ..... (⇒ p. 14)
- 5** - Stereo speaker set
- 6** - Keyboard ..... (⇒ p. 36)
- 7** - Touch pad ..... (⇒ p. 37)
- 8** - Device indicators ..... (⇒ p. 14)
- 9** - Power ON/OFF  ..... (⇒ p. 25)

## FRONT VIEW

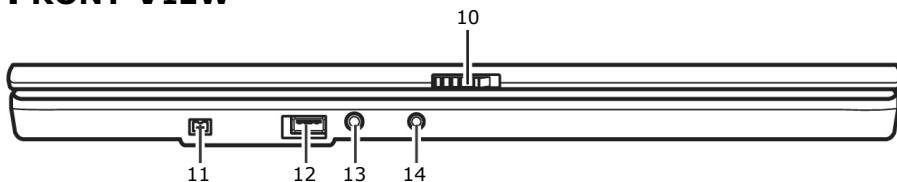

- 10**- Display catch ..... (⇒ p. 31)
- 11**- IEEE 1394 (FireWire®) ..... (⇒ p. 54)
- 12**- USB 2.0 port ..... (⇒ p. 53)
- 13**- Microphone in ..... (⇒ p. 45)
- 14**- Digital audio out **SP-DIF** ..... (⇒ p. 45)

## LEFT SIDE

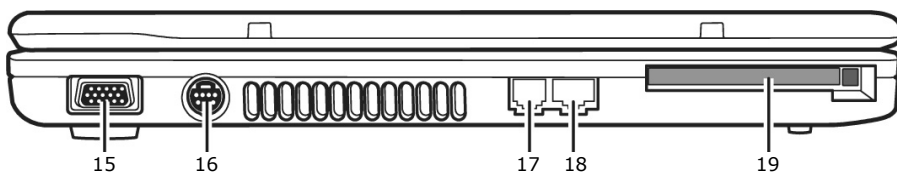

- 15**- External monitor (VGA) ..... (⇒ p. 33)
- 16**- Video out s-video ..... (⇒ p. 35)
- 17**- Modem port (RJ-11) ..... (⇒ p. 48)
- 18**- LAN port (RJ-45) ..... (⇒ p. 49)
- 19**- PC card slot PCMCIA, type II ..... (⇒ p. 52)

## RIGHT SIDE

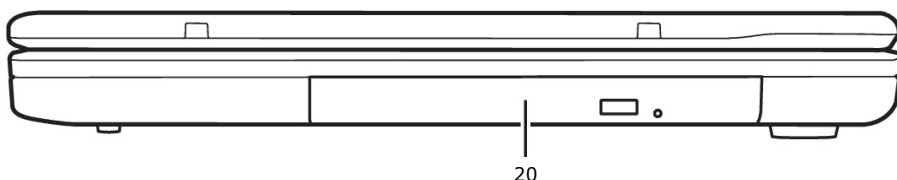

- 20**- Optical Drive ..... (⇒ p. 40)

## REAR SIDE

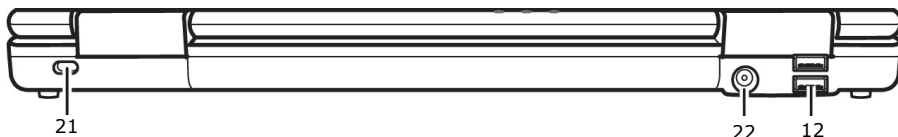

**21** - Kensington lock ..... (⇒ p. 78)

**22** - Power socket ..... (⇒ p. 25)

**12** - USB 2.0 port ..... (⇒ p. 53)

## DEVICE INDICATORS

LED's indicate the power and operating system states of the Notebook. The meaning of each LED is:



### BATTERY POWER INDICATOR

Below you will see the different meanings of the LED in various situation:

<b>On</b>	The notebook is in full operation.
<b>Blinking</b>	The notebook is in <b>stand-by</b> mode.



### BATTERY CHARGE INDICATOR

Below you will see the different meanings of the LED in various situation:

<b>Orange</b>	The battery is being charged.
<b>Green</b>	The battery is fully charged and connected to AC power.



### AC POWER INDICATOR

Below you will see the different meanings of the LED in various situation:

<b>On</b>	The notebook is turned on.
<b>Blinking</b>	The notebook is in <b>stand-by</b> mode.



#### ACCESS LED OPTICAL DRIVE

This LED **lights** or is **blinking** when the notebook is accessing the optical drive.



#### ACCESS LED

This LED lights when the notebook is accessing the hard disk.



#### NUM LOCK

This LED lights when NUM-Lock has been activated. It sets the keyboard so that numbers are assigned to certain characters, simplifying numerical data input.



#### CAPITAL LOCK

This LED lights when CAPS-Lock has been activated. This sets the keyboard to capital letters.



#### SCROLL LOCK

This LED indicates that the Scroll Lock key on the keyboard is activated. The Scroll Lock key has different functions depending on the software you are using.



#### WIRELESS LAN

Display for wireless data exchange. If the display lights **steadily** the wireless LAN function is enabled (optional feature).



#### ACCESS LED CARD READER

Feature not available.

# GETTING STARTED

---

Before you get started using your notebook, first take a few moments to read the important section on **Safety**.

This notebook comes with software **fully pre-installed**. You do not have to install any of the CDs supplied.

## Step 1

- Insert the battery before bringing the notebook into operation by sliding the battery pack into the compartment.
- Connect the power adapter.

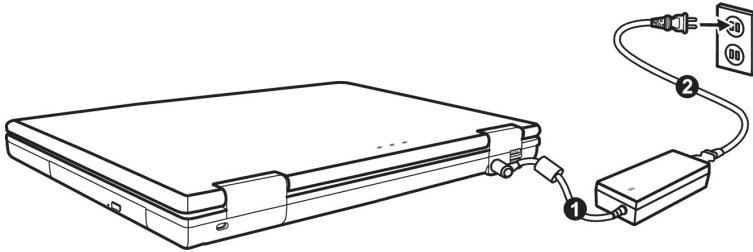

- Open the display by pushing the lock (**10**) to the right with your thumb and then opening the display to the required position with your thumb and index fingers.

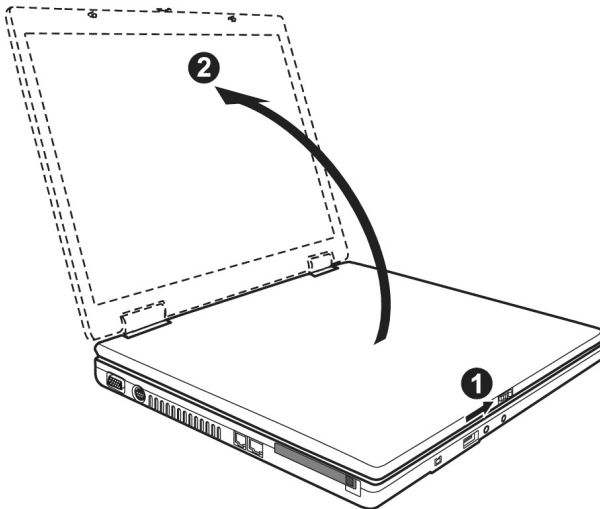

- Switch the notebook on by operating the On/Off Switch (9). The notebook starts and now goes through a number of phases.

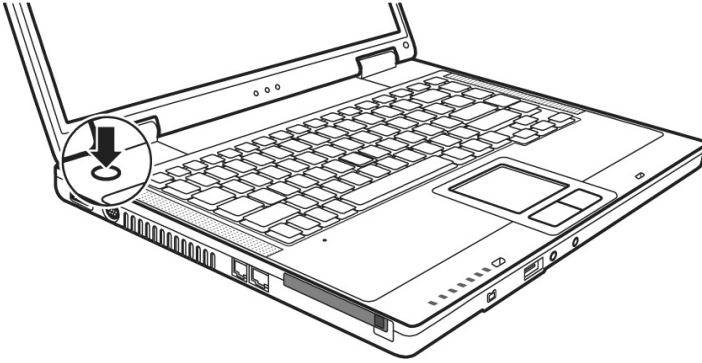

⇒ **Note:** Make sure there is no bootable CD (e.g., the Recovery CD) in the CD-ROM drive. Such disks will prevent the operating system from loading off the hard drive.

The **operating system** is loaded from the hard disk. During the initial set-up, the loading process takes slightly longer than normal to register the operating system and the individual components completely. Your operating system is finished loading when a welcome screen is shown on your display.

## Step 2

Follow the instructions on the screen. Dialogue boxes will explain any steps that need to be taken.

The greeting procedure will guide you through a series of dialogue boxes. The information in each dialogue box will explain the steps that need to be taken.

Should you have any questions just click on .

### License Agreement

The greeting procedure also displays the license agreement. Please read this carefully.

It contains important legal information on the use of your software. In order to see the full text, use the mouse and the scroll bar on the right side of the screen to move downwards until you have reached the end of the document. You accept the agreement by clicking on the **"I accept the agreement"** option field. Only by doing so will you be entitled to use the product under lawful terms and conditions and be entitled to open the sealed Windows® manual.

## Step 3

After the login procedure the Windows® desktop appears on your screen.

You will find a brief overview on the following pages.

After the login procedure the Windows® desktop appears on your screen. This can be adjusted so that the screen of your computer looks different.

However, basic operation is guaranteed.

## SHORT DESCRIPTION OF THE WINDOWS<sup>®</sup> DESKTOP

After the login procedure the Windows<sup>®</sup> XP desktop appears on your screen. (Your desktop might not look exactly like the one shown here.)

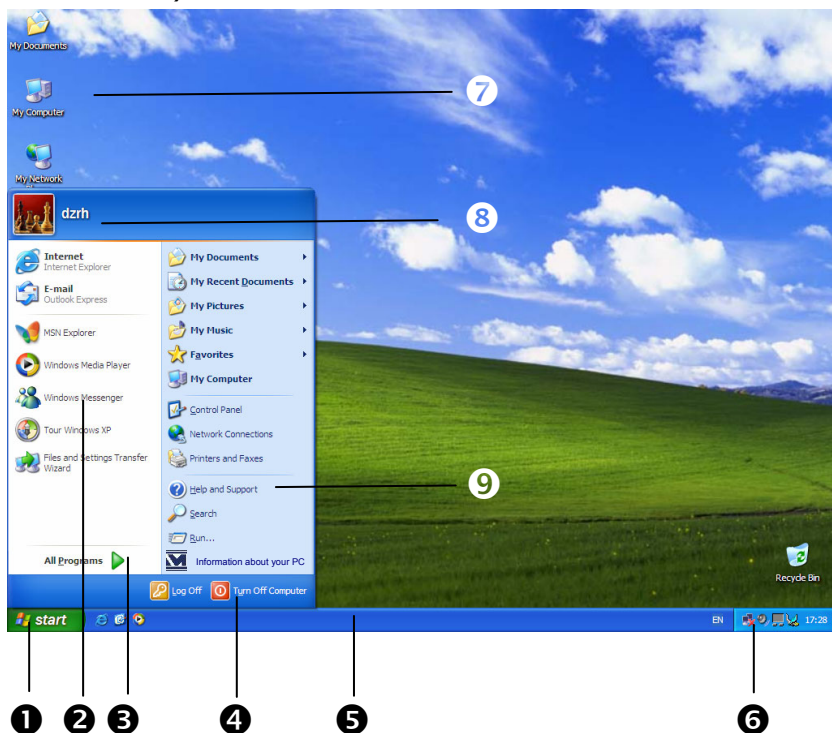

### 1. Start Button

Clicking the Start button brings up a menu where you can access help, software programs, files, and settings. For more information, click **Windows<sup>®</sup> XP Tour** on the **Start** menu.

### 2. Program Bar

The most commonly used software programs are listed here.

### **3. All Programs**

All of the software programs installed on your notebook are ordinarily listed here. Click **All Programs** to reveal an extensive menu.

### **4. Turn Off Computer**

Click this button to shut down Windows® XP and the notebook.

### **5. Task Bar**

Here you receive information and status reports about Windows® XP and which programs are running.

### **6. Desktop Icons**

Desktop icons link to their respective programs. To start a program, double-click its desktop icon.

### **7. Logged in User**

This tells you which user is logged in to your notebook.

### **8. Control Panel**

You can use the icons in Control Panel to change the appearance and functionality of Windows® XP. These icons represent options for configuring your notebook.

### **9. Windows® XP Help**

Here you can find information on using your notebook, networking, backup, and many other tasks.

# WORKING IN COMFORT



Sitting in one position for long periods can be uncomfortable. To minimize the potential for physical discomfort or injury, it's important that you maintain proper posture.

- **Back** – While sitting at your work surface, make sure your back is supported by the chair's backrest in erect position or angled slightly backwards.
- **Arms** – Your arms should be relaxed and loose, elbows close to your sides, with forearms and hands approximately parallel to the floor.
- **Wrists** – Your wrists should be as straight as possible while using the keyboard, mouse or trackball. They should not be bent sideways, or more than 10 degrees up or down.
- **Legs** – Your thighs should be horizontal or angled slightly downward. Your lower legs should be near a right angle to your thighs. Your feet should rest flat on the floor. If necessary, use a footrest, but double check that you have your seat height adjusted correctly before getting a footrest.
- **Head** – Your head should be upright or tilted slightly forward. Avoid working with your head or trunk twisted.
- **Overall** – Change your position frequently and take regular breaks to avoid fatigue.



## Main Components

<b>Subject</b>	<b>Page</b>
Power Supply .....	25
Display .....	31
Data entry .....	36
Hard Drive .....	38
Optical Drive.....	40
Subjects Concerning the CD/DVD-Rewriter .....	44
Sound Card .....	45
Modem .....	47
Network.....	49
PC Card Slot .....	52
Universal Serial Bus (USB) Port .....	53
IEEE 1394 (FireWire) .....	54
Software .....	55



## ON/OFF BUTTON

Power on or off your notebook by pressing the on/off button (9) briefly.

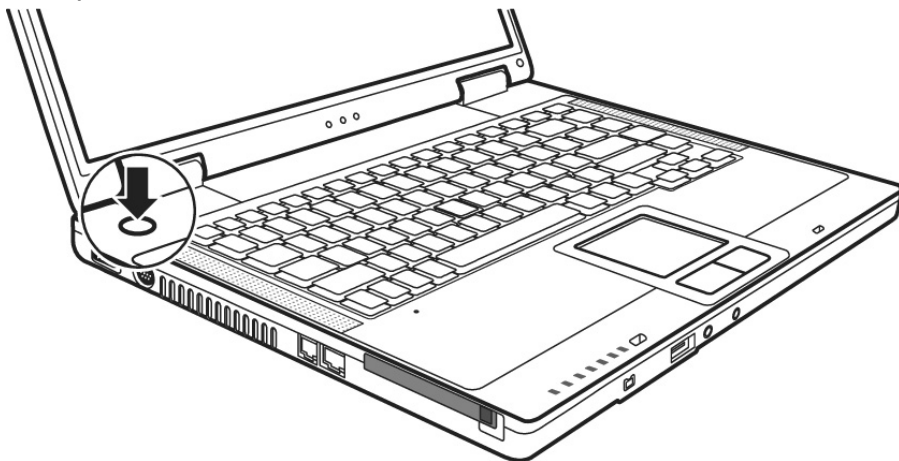

The operational indicator  will inform you about the operational status of the notebook. The notebook will always be switched off, if the main switch is pressed for more than 4 seconds.

⇒ **WARNING!** Do not switch off your notebook while the **hard disk** or the optical drive is running and the corresponding **media activity LEDs** are lit. Otherwise data may be lost. To protect the hard disk you should always wait for 20 seconds after powering down the notebook before powering it up again.

## POWER ADAPTER

Your notebook is supplied with a universal AC power adapter, which automatically adjusts to the available power source. The following levels are supported: **AC 100-240V~/ 50-60 Hz.** Please follow the power supply **safety instructions** found on page 6.

The power adapter is connected via a power cord to an AC outlet. The DC power lead from the power adapter is connected to the **rear** side of the notebook (**22**).

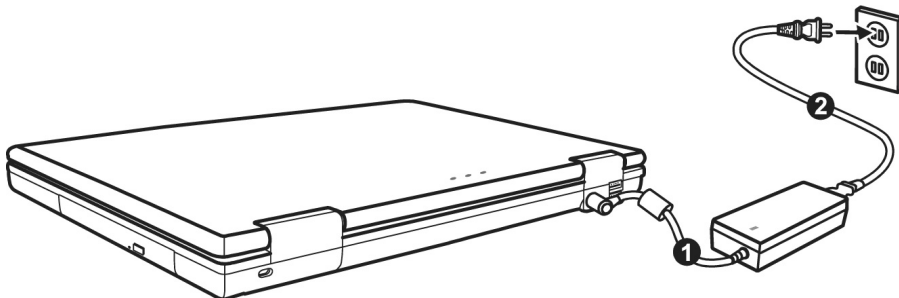

The adapter provides the notebook with power and also charges the battery. The power supply indicators of the notebook provide details on the operating state. The battery is also being charged when you are working on your notebook with the power adapter. The power adapter is still live if the notebook is not connected with it. You should therefore unplug the power adapter from the outlet if it is not connected to the notebook.

⇒ **WARNING!** Use only the power adapter and power cord supplied with your notebook.

## BATTERY OPERATION

Batteries store electrical energy in their cells and then feed it to the notebook when needed.

In order to extend the life and power of your battery, and to guarantee reliable operation, it is essential that the safety instructions on page 8 are followed.

### INSERTING THE BATTERY

Slide the battery into the battery compartment.

### REMOVING THE BATTERY

To remove the battery pack, follow these steps:

1. Make sure that the computer is not turned on or connected to AC power.
2. Place the computer upside down.
3. Slide the battery security lock outward to the unlock (🔓) position (❶).
4. Slide the battery release lever outward to the unlock (🔓) position (❷), and, while holding it in the unlock position, remove the battery pack off the computer (❸).

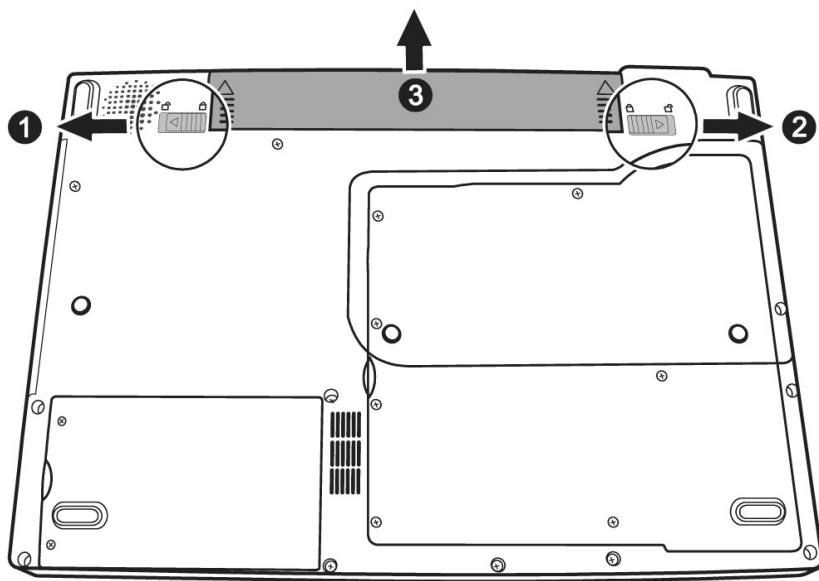

- ⇒ **WARNING!** Do not remove the battery while the notebook is running on battery power. You increase the possibility of losing data.
- ⇒ **WARNING!** Pay attention that the contacts to the battery and the notebook are not dirty or damaged when storing the battery and using the notebook. This could lead to malfunctions.

## CHARGING THE BATTERY

The battery is charged via the power adapter. If the power adapter is connected, it charges the battery automatically, whether the notebook is turned on or not. When the notebook is switched off, full charging takes a few hours. If the notebook is switched on, the charging process takes a significantly longer time.

You will find the meaning of the battery LED  on page 14.

- ⇒ **NOTE:** The charging process will be interrupted if the temperature or the voltage of the battery is too high.
- ⇒ **NOTE:** Please charge and discharge the new battery completely two to three times in succession, so that it will reach its complete efficiency!

## DISCHARGING THE BATTERY

Operate the notebook by means of the battery until it switches off independently because of the low battery charge.

Do not switch the notebook off, even if a warning appears on the display. Deactivate **all energy options** in the **system control**, above all **alarms** and **power functions**. Think about saving your open files in good time, to avoid a possible loss of date.

## BATTERY POWER

The battery life will vary according to how the power saving functions are set, the way you work, the size of the main memory and the display type.

When working in Windows an audible warning alert will sound as soon as the battery level drops below a set minimum value. When this happens, the processing power is reduced in order to save power.

⇒ **NOTE:** Battery warning signals and "Low-Battery" mode will be heard immediately when the power pack is first connected.

### CHECKING THE BATTERY LEVEL

In order to check the current level of the battery, move the cursor over the power symbol in the taskbar.

The symbol of a battery is displayed during battery operation:

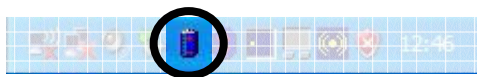

You will receive additional information about settings if you double click on this symbol.

- ⇒ **NOTE:** If you ignore the warning signal when the battery level is low, your notebook goes into suspend mode.
- ⇒ **WARNING!** If the battery is empty, your data will not be retained for long in Standby/Save-to-RAM mode.
- ⇒ **WARNING!** Never remove the battery while the notebook is switched on or if the notebook has not yet gone into suspend mode, as this may lead to loss of data.

# POWER MANAGEMENT

Your notebook offers automatic and modifiable power saving functions that you can use to maximize battery life and reduce overall operating costs. The power saving modes are known as standby mode and suspend (hibernate) mode.

## STANDBY MODE

When in standby mode, the contents of the RAM of your notebook are preserved while practically all other components of your notebook are shut down, reducing your power consumption to a minimum. By pressing any key on the keypad, you can bring your notebook back to the fully operational state. You will restart at precisely the line in which you were working prior to the interruption. The computer takes less time to go into and come out of standby mode, but uses more power than suspend (hibernate) mode.

## SUSPEND (HIBERNATE) MODE

The hibernate mode is an alternative to a complete shutdown of the notebook. In this mode all data from RAM (system and graphic data) are copied to the hard disk as a file. As soon as the data has been safely saved, the notebook powers down. When the notebook is switched on again, this file is written back to RAM by the BIOS. In a few moments the notebook is in the exact state as when it was last used. If while working on a document the notebook is closed (assuming the correct ACPI setting), the notebook saves the data in RAM for you automatically. You will restart at precisely the line in which you were working prior to the interruption. The computer uses no power while it is in suspend (hibernate) mode, but it takes a little longer for the computer to go into and come out of hibernation compared to standby.

# DISPLAY

Unlike a normal monitor, the TFT display does not produce either radiation or flicker.

## OPENING AND CLOSING THE DISPLAY

Display catches (10) keep the display closed when the notebook is not in use.

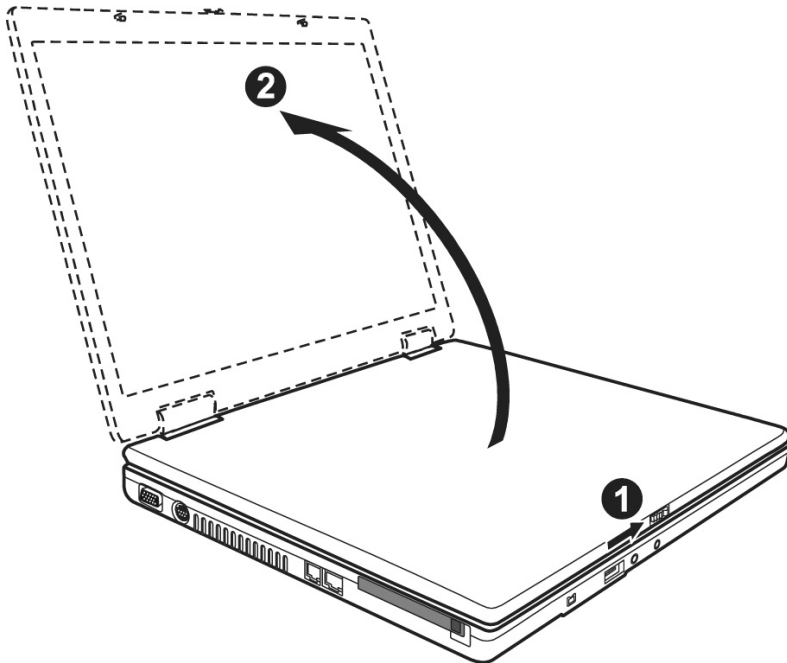

To open, use your thumbs to push the bar to the right (1) then lift (2) the display with your thumbs and index finger and position it as desired.



**WARNING!** The display should **not** be opened fully to **120°**. Do not try to forcibly open it.

The opening and closing of the display can be assigned various functions via the Power management feature.

## SCREEN RESOLUTION

The integral screen has a native resolution of **1280 x 800** pixels. If you change to a presentation with different characteristics in the Windows '**Display Characteristics**' Help Program, the display will not appear on the whole area of the screen, among other effects.

Using a higher resolution can lead to distortion of the display, especially with text. Using a lower resolution may cause the display to use only a portion of the screen area.

You will adjust the presentation to the mode supported with the Windows '**Display Characteristics**' Help Program.

## CONNECTING AN EXTERNAL MONITOR

The notebook has a VGA port (15) for connecting an external monitor.

1. Shut down your notebook.
2. Connect the video signal cable of the external monitor to the VGA port of the notebook (15).
3. Connect the external monitor to the electrical socket and power it up.

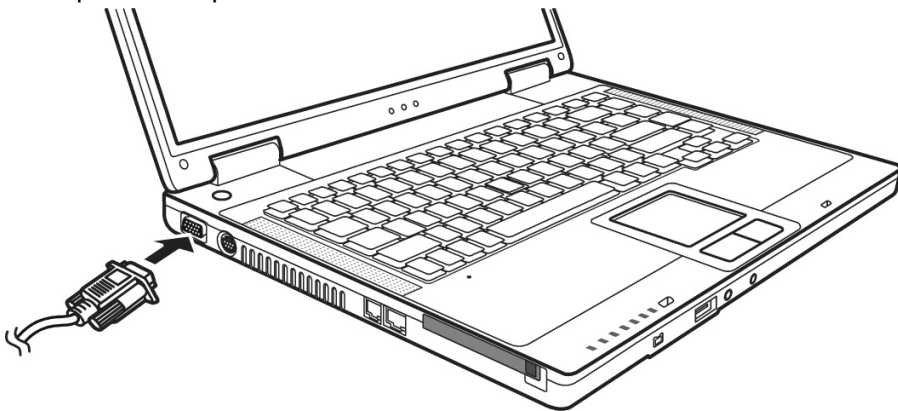

4. Start your notebook.

There are two options for setting up an external monitor:

### 1. Clone your Desktop

Press **<Fn> + <F5>** to activate the external monitor. The notebook display will be switched off. Adjust the display settings following the external monitor specification. Press **<Fn> + <F5>** once more and both displays are switched on.

Press **<Fn> + <F5>** again to deactivate the external monitor. The notebook display will be switched on.

## 2. Extend your Desktop

This option does not support the key combination **<Fn> + <F5>**.

Right click anywhere on your desktop and select **"Properties"** to start the **"Display Properties"** program.

- Select the **"Settings"** tab and left click on the second display ❶.
- Check the option **"extend my Windows desktop onto this monitor"** ❷ and press "ok".
- To deactivate the extension uncheck the option "extend my Windows desktop onto this monitor".

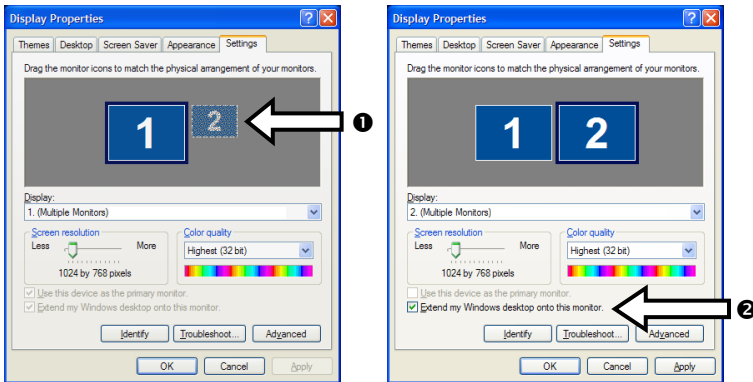

You can change the resolution and colour depth for either display in this screen. However, you may have to decrease the depth of colour if you increase the resolution since the video memory has a limited capacity.

## CONNECTING A TV

The Notebook has a port **(16)** for connecting a TV. To connect and configure the Notebook for a TV:

1. Shut down your notebook.
2. Connect the signal cable of the TV to the TV out port **(16)** of the Notebook.

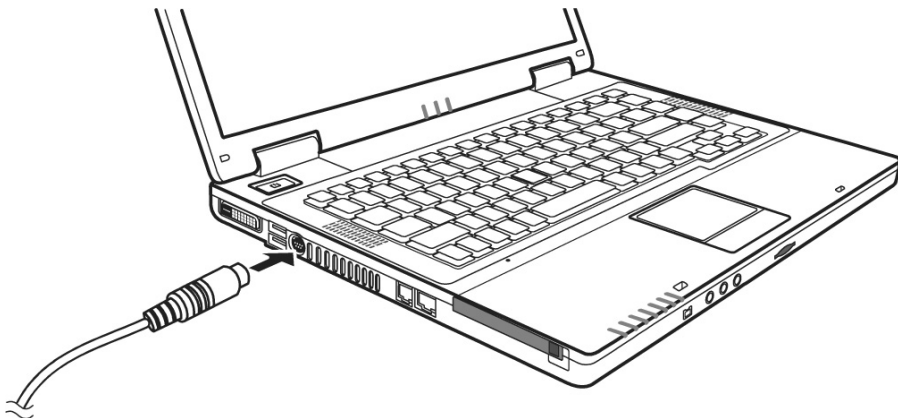

3. First turn on your TV and then turn on your notebook. Switch on your notebook and boot it properly.

⇒ If the option **Extend Windows Desktop to this Monitor** in the program **Display Properties** is activated, then it must be deactivated first in order to change the display to the TV set.

# DATA ENTRY

## THE KEYBOARD

By dual assignment of certain keys you have the same range of functions available to you as with a normal Windows keyboard. Some functions are input using the **Fn** key, which is normal on notebook computers.

## NOTEBOOK-SPECIFIC KEY COMBINATIONS



Switches the wireless LAN on and off.

### NOTES:

- This function works only if an optional Mini PCI wireless LAN card is installed.
- The FAA (Federal Aviation Agency) has deemed it unsafe to operate wireless devices in aircraft as this may interfere with flight safety. Remember to turn off wireless LAN when using your computer in the airplane.



Decreases the volume.



Increases the volume.



Toggles the display screen between internal monitor, external monitor and simultaneous display.



Reduces screen brightness.



Enhances screen brightness.



Switches the loudspeakers on / off.



Switches the backlight off to save power. Pressing **any** key switches the backlight on again.



Power saving functions. This key combination is set to **power down** by default. To adjust this key to your own needs go to display **properties** in **power saving**.

## TOUCH PAD

The touchpad (**7**) is positioned in front of the keyboard.

The pointer follows the direction which is specified by moving your finger or thumb over the touch pad.

**Do not** use a ball-point pen or other object on the touch pad, as this could damage or cause a malfunction of your touch pad. Below the touch pad are the left and right mouse buttons which can be used as on a normal mouse.

You can also perform a direct click or double click using the touch pad by tapping the surface briefly once or twice.

In the Windows Control Panel you will find a number of useful settings that will make using the touch pad easier.

# THE HARD DRIVE

---

The hard drive is the main storage medium combining large storage capacity and rapid data access.

The Windows operating system cannot use the full capacity of the hard drive, which means that there will be a difference between the capacity that the BIOS displays and what the operating system displays.

The hard drive contains the operating system of the computer, other application programs and backup files. These programs and files are pre-installed on your notebook, so you may note that some of the space on your hard drive is already taken.

Whenever the computer is accessing the hard disk, the corresponding LED  (⇒ p. 15) illuminates.

⇒ Never switch off the computer while the busy indicator is lit since this may result in loss of data.

If you are looking for a file on the hard drive and you know the name, go to Search on the Start menu to find the file. Following is some general information on where you might find some common files.

Usually your hard drive is divided into several partitions, as shown below. The partitions of your hard drive may vary from what is shown here.

Local Disk	C:	Windows XP Software programs Your documents
BOOT	D:	Drivers for internal PC components Installation files for software that came with your PC
Recover	E:	Restore software

## IMPORTANT DIRECTORIES

The most important directories preinstalled on your notebook are shown below. These directories may vary from what is shown here.

- ⇒ **WARNING!** Do not delete or modify these directories or their contents since data could be lost or the functionality of the system could be at risk.
  
- ⇒ **Also pay attention to this:** You will no longer be able to carry out the recreation of the supply status by means of the Support Disk (⇒ p. 69), if you have converted the Recovery Partition into a NTFS file system.

**C:\** This is the main hard disk drive partition for your notebook. It is where your program files, settings, and documents are stored, as well as files necessary for running Windows XP.

**C:\Program Files** Includes files belonging to software programs.

**C:\Windows** The main directory for Windows XP.

**C:\Documents and Settings** Includes the settings and documents for all users.

**D:\** Includes files for restoring hardware components and software programs.

**D:\Driver** Drivers for internal notebook components.

**D:\Tools** Includes installation files for software that came with your notebook.

**E:\** Includes files for restoring the entire notebook to working order.

**E:\Recover** Includes the files needed to perform a system restore.

# THE OPTICAL DRIVE

---

## LOADING A DISC

⇒ **Note:** Do not place protective foils or other stickers on your CD's. To avoid damage to your drive, do not use deformed or damaged CD's. Attention: Do not use scratched or dirty disks, discs with pieces broken off or disks of poor quality. Because of the high speeds in the drive the disks might break and damage your data as well as your drive. Examine the disks before you enter them. If damage or dirt is visible, you should not use them. Damage caused by faulty media is excluded from warranty and their repair must be charged.

1. Press the eject button at the optical drive to open the tray.
2. Carefully pull out the disk tray completely.
3. Place the disc on the tray so that it lays flat with the label facing upward.

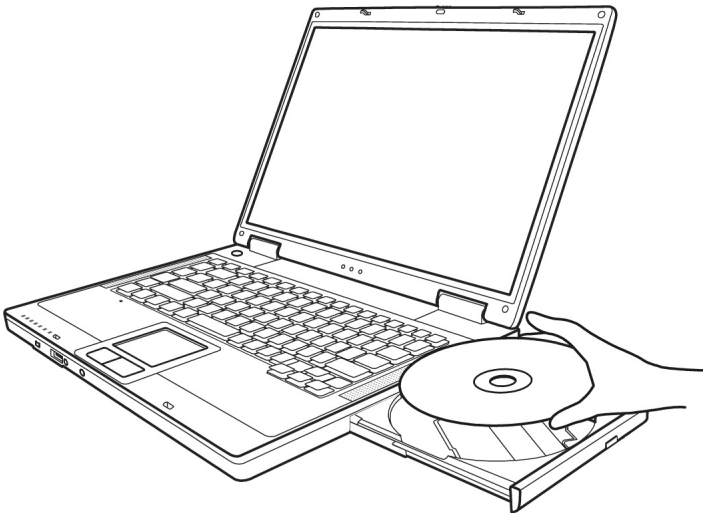

4. Check that the disk can turn freely and then close the disk tray back again into the optical drive carefully until it locks.

The 'F' drive letter will have been allocated to your optical drive in the delivery status. You will have easy access to your files on your disks with Windows Explorer (workstation). Start Explorer through the Start Menu or by pressing the Windows Button  and the 'E' Button at the same time

The pre-installed media reproduction will be used automatically during access to DVD videos (or audio and video files on normal data CDs).

5. Press the eject button if you want to remove a disk.

➤ **WARNING!** While the notebook is accessing the optical drive the media activity indicator is lit. Do not try to remove the CD from the drive while this LED is lit.

## PLAYING BACK AND RETRIEVING DATA FROM DISCS

Your notebook is able to playback and to retrieve Audio CDs, DVD Movies and Data discs.

After loading the disc your operating system will open a selection window with different options for playback. Normally the following programs are provided:

- Windows® Media Player
- Power DVD
- Power Cinema

If your operating system doesn't open the selection window you still have the possibility of the access via the explorer or "My Computer".

## EMERGENCY EJECTION OF A BLOCKED DISC

If the tray fails to open automatically, then the tray can be opened manually provided there is an opening for emergency ejection.

Restart your notebook and if the tray is still locked proceed as follows:

1. Shut down Windows and switch off your notebook.
2. Insert a long thin object (like a straightened paper clip) into the emergency ejection opening until you feel resistance.

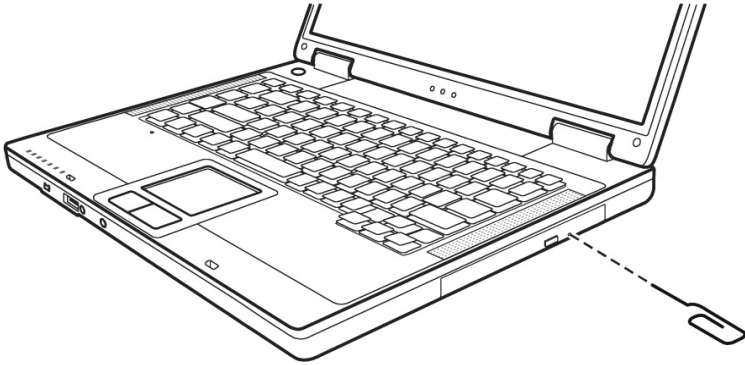

3. Press lightly and the tray will open.
4. Remove the disc and restart the notebook.

## REGIONAL PLAYBACK INFORMATION FOR DVD

The playback of DVD movies includes the decoding of MPEG2 videos, digital AC3 audio data and the deciphering of CSS protected contents.

CSS (sometimes called copy guard) is the name of a data protection program incorporated by the movie industry as an action against illegal copies.

Among the numerous regulations for CSS licensees the most important ones are the country specific playback restrictions.

In order to facilitate the geographically restricted release of movies, DVD titles are released for certain regions.

Copyright laws require the restriction of each DVD movie to a certain region (usually the region, in which it is sold).

DVD movie versions can be published in several regions but the CSS regulations require that each CSS decipherable system may only be used in one region.

⇒ The decoding software included with your PC may be changed for regional DVD decoding **up to five times**, after which the drive will only play DVD movies for the region setting last entered. Changing the region code after that will require factory resetting which is **not** covered by warranty. If resetting is desired, shipping and resetting costs will be billed to the user.

## **SUBJECTS CONCERNING THE CD/DVD-REWRITER**

This Section only relates to devices that have been supplied with a CD-RW, a combination drive or a DVD-RW drive.

First of all, you receive information on the so-called **blank discs**.

These media, requiring a CD rewriter (burner) to produce CDs are called CD recordable (CD-R) or CD rewritable (CD-RW).

### **RECORDABLE/REWRITEABLE DISCS**

Normal Discs are pressed from a digital, glass master and then sealed. In the case of blank disc, the information is burnt onto the disc with the laser of the Rewriter. Therefore these discs are more sensitive than normal CDs.

Please avoid the following when using recordable/rewriteable discs

- especially blanks - that have never before been used:





- radiation by direct sunlight (UVA/UVB)
- scratches and damage to the disk surface
- extreme temperatures

## THE SOUND CARD

Your notebook has an integrated stereo sound card (on-board) with 16-bit and 3D spatial sound effects (3D). The sound card is compatible with the industry standard **Sound Blaster** and **Microsoft Sound System Version 2.0**. This guarantees optimal support for all popular programs and games.

If you wish to alter the base volume, click on the loudspeaker symbol in the task bar. A double click opens the sound mixer.

By means of the key combinations (⇒ p. 36) you still have the possibility to regulate the volume.

By using the keys   you increase the volume and by using   you decrease it.

### EXTERNAL AUDIO PORTS

Your notebook has a loudspeaker, so you can always playback sounds without additional equipment. The use of the external connections gives you a good opportunity to connect your notebook to external devices.

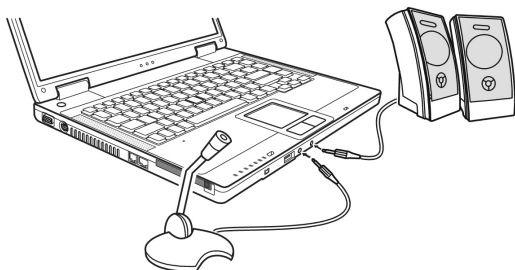

<b>Microphone in</b> (13)	<ul style="list-style-type: none"> <li>▶ For recording via an external microphone.</li> </ul>
<b>Digital audio out</b> <b>SP-DIF</b> (14)	<ul style="list-style-type: none"> <li>▶ For sound reproduction via external stereo equipment such as loudspeakers (active) or headphones.</li> </ul> <p>The notebook automatically recognizes if an analog (3.5mm stereo plug) or a digital (optical) link has been created. The internal loudspeakers are switched off when this port is used.</p>

By using the external connections you have the possibility to connect your notebook with external appliances.

If the external audio links have a dual function, then your notebook is equipped with a surround sound system. The bundled software allows you to make the necessary settings:

1. Click the following symbol in the taskbar:



The help program for the audio configuration is now invoked. A large number of settings can be carried out with this.

It is also used to set the loudspeaker configuration you are going to use for the surround sound.

Click the **"Audio I/O"** tab to set the system for your needs.



Four configurations modes are available to you:

- **headphones**
- **2-channel mode for stereo loudspeaker output**

This chapter is intended for systems equipped with a modem or ISDN jack.

## WHAT IS A MODEM?

The built-in modem is able to receive data according to the ITU standard for V.90 transmissions with up to 56 Kbit/s.

Since the power output of modems is restricted due to the regulations of some telecommunication providers, the possible maximum download speed can be restricted. The actual speed may be dependent on the online conditions and other factors.

Data sent from the user to the server are transmitted with 31.2 Kbit/s. Prerequisite for this high speed reception is an analogue telephone line compatible with the V.90 standard and a corresponding compatible Internet provider or company-owned host computer.

The modem is fitted with an RJ-11 interface, into which a standard telephone lead can be plugged. If your modem is a combo card please make sure that it is used only with the appropriate port.

⇒ **WARNING!** Use only with an analogue telephone line. The modem cannot withstand the voltage levels of digital telephone systems such as PBX or lines such as ISDN or Broadband services. (see safety instructions on page 7).

## MODEM PORT

Insert one end of the RJ11-connection (telephone plug connector) into the modem/network interface (**18**) and the other into an analogue telephone socket that is easily accessible.

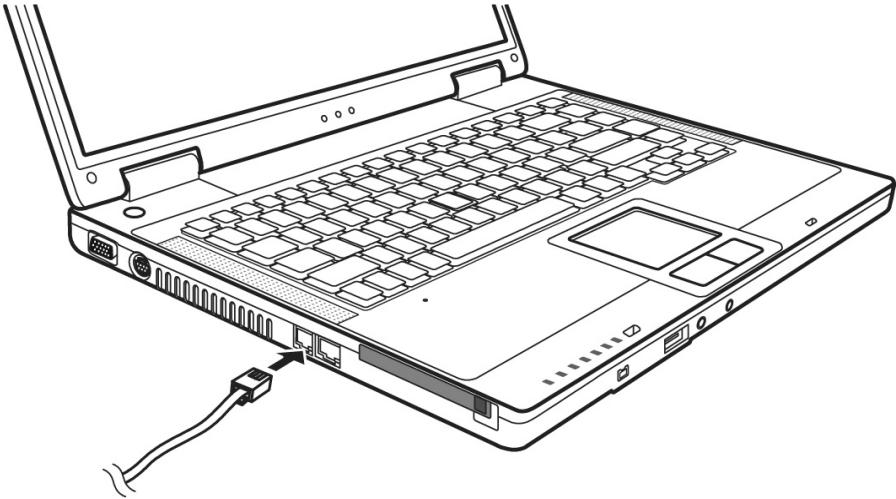

⇒ **NOTE:** Do not place the notebook in Suspend (or Sleep) mode if you are connected to your Internet provider, since this will cause the modem connection to be lost.

# THE NETWORK

---

## WHAT IS A NETWORK?

A network means connecting your notebook to one or several other computers. Users can transfer data between computers and share resources such as printers, modems and hard disk drives.

Here are some practical examples:

- You can exchange E-mail and manage appointments in an office.
- Users can share a printer in a network and save their data on a central server.
- Users can share one modem among computers for Internet access.
- Two or more computers can be connected to play network games or share data.

## FAST ETHERNET-NETWORK

If your notebook has a Fast Ethernet connection, you can use this to connect to a network.

The following explanation refers to notebooks with a network connector.

Connect one end to the RJ45 connection (Western plug) at the network interface of your notebook (**18**) and the other to another PC or a hub/switch.

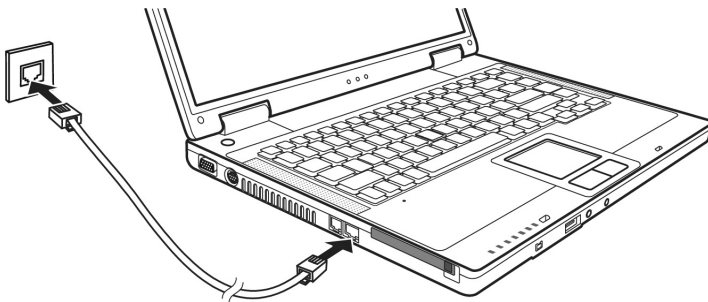



The Windows XP Help and Support Centre offer extensive information about networking your PC. You can access this information by clicking on **Start**, then **Help**.

# TROUBLESHOOTING WITHIN THE NETWORK

 Why does an error message appear when I click on the network environment?

 The **computer name** must be unique on the network and may not be the same as the **task group**.

 It appears that the network boards are unable to communicate. What might be the problem?

 Maybe one of the used network boards works with a **different speed** (e. g. 10 instead 100 Mbit) and your network computer is unable to recognize this. If necessary, set the network driver to the compatible speed.

If two PCs should be linked you require a **cross-link cable**, otherwise use a **patch** cable.

In addition, check the **protocols** and the **configuration**.

 The data transmission is incorrect or very slow. What might be the problem?

 Maybe you have the wrong cable (UTP / CAT3 or lower) or the problem is the proximity of a power cord or another source of interference.

For further hints on troubleshooting search for "network errors" in Windows Help and Support.

## WIRELESS LAN

Wireless LAN is an optional feature. This function allows you to create a wireless network link with an access point or directly with another wireless-enabled PC.

To **turn on** the WLAN function press the **Fn+F1** hot key. The WLAN indicator (∇) glows to indicate that the computer is ready for WLAN connection.

To **turn off** the WLAN function press the **Fn+F1** hot key. The WLAN indicator (∇) will be off.

⇒ **ATTENTION:** Make sure the Wireless LAN option is switched OFF in any environment where it might interfere with critical and sensitive devices, e.g., on aircraft, in hospitals and other medical centres, etc.

### CONDITIONS

An access point is a wireless transmitter that communicates with your notebook and controls access to the network connection (e.g., a home network or a broadband connection such as DSL). Wireless access points are often found in offices, airports, universities or Internet cafés. They offer access to networks or to the Internet. **Access authorizations** are normally needed. A fee may be required to use a public access point. To set up a wireless network to share Internet access, files, and printers at home, you will need an access point, a router, and a broadband (DSL or cable) modem. Some access points can also serve as a router and/or a broadband modem. Check with your retailer or Internet Service Provider to find the best solution for your needs. A link to another computer with wireless LAN functionality can also be created **without an access point**. This will allow you to share files, but you will need an access point and a router to share an Internet connection. The wireless network link works according to standard **IEEE 802.11g** which is also compatible with the IEEE 802.11b standard. The standard 802.11a is not supported. If encrypted transmission is used, this must operate according to the **same principle on all devices**. Encryption is a method of protecting the network from unauthorized access. The transmission speed (max. 54 Mbps) can vary according to the **distance** and **loading** of the partner. The transmission speed (max. 54 Mbps) can vary according to distance and other factors. If i.e. the other devices support the 802.11b standard the transmission speed can be max. 11 Mbps.

# THE PC CARD SLOT

---

## INSTALLING A PC CARD

Follow the PC card installation instructions that are given for use under Windows<sup>®</sup> and have the necessary driver software ready.

⇒ Remove the dummy card from the PCMCIA Slot before installation. Replace the card to protect contacts against dirt if the slot is not used.

Once you have started Windows<sup>®</sup>, slip the card carefully into the slot provided.

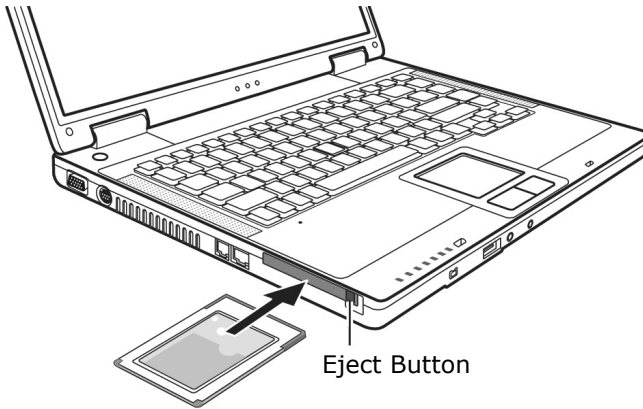

When the card is fully inserted two audible signals will be heard, provided it has been correctly recognized and successfully configured.

If only one signal is heard, this signifies a problem with the card recognition. In this case, follow the instructions that accompany your new PC card.

## REMOVING A PC CARD

To remove your PC card:

1. Press the eject button next to the slot.

⇒ **Attention!** The Eject Button should be **pressed in** during transportation, because the danger will arise that the button will break off otherwise.

# UNIVERSAL SERIAL BUS (USB) PORT

USB ports provide an easy way to connect many peripheral devices to your PC (**12**). You can use any USB device with any USB port. Your notebook will have **3 USB 2.0 connection sockets** (USB 1.1 compatible).

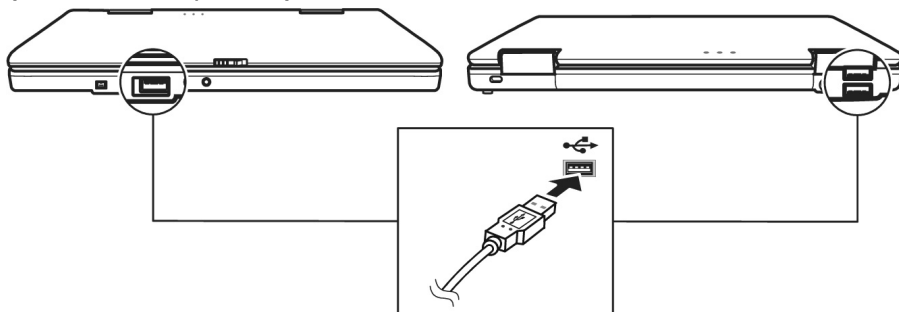

Some USB devices require that you reinstall software drivers when you connect the device to a different USB port than the one originally used. This can be avoided by always using the device with the same USB port.

Devices connected directly to the USB bus should not draw more than 500 mA. Should the devices need more power than this, it will be necessary to provide a powered hub. The data transfer speed is 1.5 Mbit or 12 Mbit, depending on the device connected.

# IEEE 1394 (FIREWIRE®)

---

The IEEE 1394 port (**11**) (also known as iLink® or FireWire®) provides an easy and high-performance way of connecting high-speed storage, imaging, and many new types of audio/video devices easily.

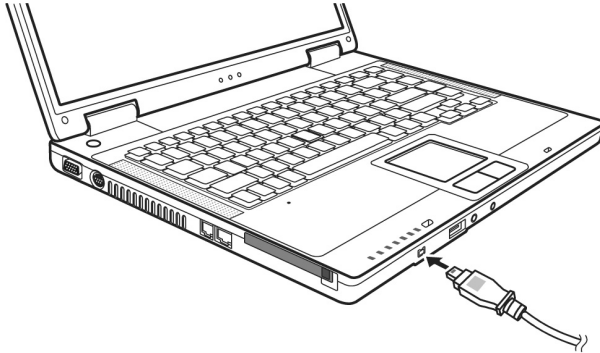

## APPLICATION OPTIONS FOR IEEE1394

- Connection of digital devices of the entertainment industry, such as set-top speakers, digital video and camcorder, 'Digital Versatile Disk' (DVD), television etc.
- Multimedia applications and video processing.
- Input and output devices such as printers, scanners, etc.

## TECHNICAL SPECIFICATIONS

- Depending on the application, the maximum data transfer is about 100, 200 or 400 Mbit/s, corresponding to a data throughput of up to 50 MB per second.
- The device can be plugged in or unplugged during operation (hot plugging).
- The standardised cord ('Shielded Twisted Pair' -STP) includes 6 strands. Two lines are live (8V up to 40V, 1.5 A max.) and can be used as an external power supply. The four signal lines transfer data or control information. Some devices do not require a power supply via the cord so that four pole plugs are used.

There are many kinds of help and information for using your PC. This section tells you where to get help with the Microsoft® Windows® XP operating system, software programs, and your notebook.

## GETTING TO KNOW WINDOWS XP

Windows XP offers different options to understand its operation. We will mention only a few of those options here:

### WINDOWS® XP MANUAL

This printed manual provides general information about the operating system. We recommend that all beginning users or users of previous versions of Windows® read this information. It can be found with the CDs in the accessory box that came with your notebook.

### WINDOWS® XP HELP AND SUPPORT Help and Support

An answer to almost every question can be found in this program. This help function fully covers the Windows operating system. It is helpful for both beginners and professionals. You can print or bookmark the information, which is categorized into topics. You start like this:

5. Click on 

6. Now select 

## MICROSOFT® INTERACTIVE TRAINING

To obtain an overview over the functions and the operations of Windows<sup>XP</sup> we **recommend** the program „Windows<sup>XP</sup> Step by Step Interactive“.

The objective of the program is to ease both the initial contact with and the transition to Windows<sup>XP</sup> for beginners and experienced users.



The program is categorized into many small topics, so that the user can gain access to the information according to his requirements. Multimedia effects including video clips and speech output convey the contents of the various topics clearly and efficiently.

Interactive tasks allow you to apply the conveyed topics in a simulation environment of the program to facilitate a successful learning experience.

Windows XP Step by Step Interactive covers ...

- operating Windows XP
- new functions in Windows XP
- the process of log-on log-off and user administration for creating a security structure
- configuration of the Internet access
- operating the email program
- ... and much more!

Use this program to better understand your PC and to operate it optimally. It also is an additional source of information for recognizing and eradicating potential problems. You start the program like this:

1. Click on 
2. Select now **All Programs** 
3. You will find the program in „**Accessories**“, „**Microsoft Interaktives Training**“.

# INSTALLATION OF SOFTWARE

**Note:** If your operating system is configured that the installation procedure accepts only signed drivers (default) and software this information screen will appear:



Although the software lacks the digital signature it may work properly. Click on "Tell me why this testing is important" to get detailed information.

Confirm by clicking on "**Continue Anyway**".

The software included in delivery is **already pre-installed** in the factory.





It happens that during installation procedure important files can be changed or even cancelled. To avoid eventual problems in using older files after installation, make sure to safeguard your hard disk.

Please follow the instruction of the software vendor. We will describe a typical installation. Once you insert a CD, the installation menu is started automatically.

Run the **Program Compatibility Assistant** under **Programs, Accessories**, if you are not sure about the compatibility of the Program to be installed.

**Note:** If the automatic start does not work, it is likely that the so-called **Autorun** function has been deactivated. Read the respective chapter in Windows Help on how to activate this function.

An example for the manual installation without the autorun function:

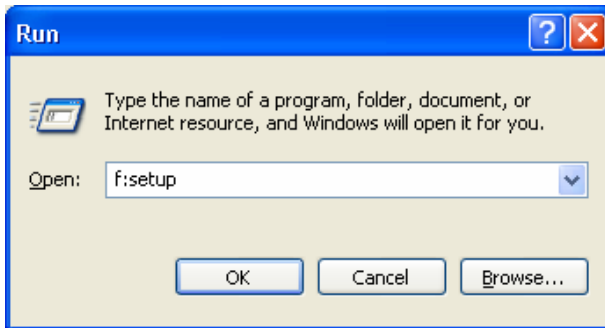

1. Click on  and select the item .
2. Now enter the letter of the CD-ROM drive followed by a colon and the program name setup:



3. Click on "OK".
4. Follow the instruction given by the program.

## SOFTWARE DEINSTALLATION

In order to remove installed software from your PC, follow the next steps:

1. Click on 
2. Click on 
3. Then select the following program:



Select the respective program, start the deinstallation and follow the instructions on the screen.

If the system becomes unstable due to a certain software or driver, you are able to recover the stability of the system with various methods (see starting on page 68). Then you do not need to uninstall the driver.

## WINDOWS ACTIVATION

Microsoft is committed to the protection of intellectual property rights and the reduction of software piracy. Therefore Windows XP contains software-based product activation technology. Your copy of Windows XP has already been **activated for your PC**.

Product activation is needed if some components of your PC have been replaced or you use a non-authorized BIOS. If necessary you can activate Windows XP as often as requested.

You will probably need to activate Windows XP by telephone even if Internet Activation is available. This is due to the pre-activated SLP version which runs with a special Product-ID. However, activation needs your unique Product ID which can be found on the **Certificate of Authenticity** sticker on your PC housing. When you call, please inform your agent that you are running an OEM-(SLP) version of the software.

## THE BIOS SET-UP-PROGRAM

In BIOS setup (Basic Configuration) there are a number of configurable parameter settings available for your notebook. For example, you can change the operating mode of the interfaces, security features or power management.

⇒ **WARNING!** The notebook is factory pre-set to guarantee optimum operation. Only modify the parameters if necessary and if you are familiar with the configuration options.

### RUNNING THE BIOS SET-UP

You can only run the BIOS configuration program at system start-up. If the notebook has already started, power it down and then up again. Press the **F2** function key in order to start the BIOS-SET-UP.

### NAVIGATING THE BIOS UTILITY

The Menu of the BIOS Program contains several Main Points. Each Menu Point will trigger a function or call up its own screen page with new setting options. Select the required option in the Start Page with the Arrow Keys. A Menu Point will stand out automatically if you move to it. Select the required Menu Point with the Enter key. Help in English will be available to you with the **F1** key. You will also be able to select individual fields on screen pages with option fields with the help of the Arrow keys. You will see one or more *values* next to each field. The first (or only) value will be emphasized if you move across a field. An emphasized field can be changed by pressing +/- or F5/F6. Some fields will require a value to be entered instead of a selection from predetermined values. Other fields are prescribed automatically by the system and cannot be changed. Press the ESC key to return to the previous level.

⇒ **Note:** If you are unsure if your parameter settings are correct, you should load the "**Set-up-Defaults**".



## First Aid



<b>Subject</b>	<b>Page</b>
FAQ.....	63
Data and System Security .....	65
System Recovery .....	68
Troubleshooting .....	71
Maintenance .....	74











# FAQ – FREQUENTLY ASKED QUESTIONS

---

-  When do I have to activate Windows?
-  Your software has been preactivated in the factory. An activation will only be required, if ...
- ... several components are replaced by others.
  - ... you installed a new motherboard.
  - ... a different BIOS version has been installed.
  - ... you install the software to another computer.

-  What is the Windows activation?
-  Your operating instructions include a chapter about this subject.

-  How do I perform a data backup?
-  Use the program Backup for this.
- It is important that you follow the operating instructions of these programs.
- Make a backup and another backup of selected data to an external medium (CD-R, CD-RW, DVD-R, DVD-RW, SD card, etc.), to familiarize yourself with the technique.
- A backup is unsuitable if you are not able to recover the data, the medium (floppy disk, CD-R, etc.) is defective or no longer available.

-  Do I still have to install the enclosed CDs/DVDs?
-  No. Basically all programs are already preinstalled. The disks are only intended as backup copies.
-  When is the recovery of the factory setting recommended?
-  This method should be chosen as the last resort. Read chapter "**System recovery**" on page 68 concerning the possible alternatives.
-  Why is the boot partition missing when booting from the support/ application CD?
-  The first partition is formatted with the file system NTFS. Compared to FAT32 this file system offers more security and a more efficient access. However, NTFS partitions can only be read from operating systems supporting this. This is not the case in the aforementioned CD.

# DATA AND SYSTEM SECURITY

---

The programs described below are part of your Windows operating system. You will find additional information on these programs in the Windows Help file.

## DATA SECURITY

Back up data regularly on external media such as a CD-R or CD-RW. Windows offers both a **Backup** program and a **Files and Settings Transfer Wizard**.

Both programs are found in **Accessories/System Tools** within the Start menu. You should make a backup disk with all your passwords and the operating system's original configuration.

## MAINTENANCE PROGRAMS

You can avoid some hardware and software errors with disk maintenance programs such as **Disk Defragmenter** and **Disk Cleanup**. The program **System Information** can also be helpful since it gives you detailed information about your system configuration. You will find these programs in **Accessories/System Tools**.

## PASSWORD RESET DISK

To protect individual user accounts from complications resulting from lost passwords, users should create a password reset disk and keep it in a safe place. If the user should forget his/her password, the password can be reset with the password reset disk so that the user has access again to his/her local user account.

Windows Help describes how to create a password reset disk.

**Windows Update** is the online updating of Windows. Use Windows Update to download elements such as security updates, important updates, the newest help files, drivers and Internet products from the Internet.

The website is regularly augmented by new content, so that you can download the newest updates and error corrections at any time, to protect the notebook and guarantee its functioning.

Windows Update will search through the notebook and provide a list of individual updates specially for the configuration of your notebook.

Each update that Microsoft regards as important for the operation of the operating system, programs or hardware components will be classified as an "important update" and automatically selected for installation for you.

Important updates will be provided to remove known problems and to protect the notebook against known security risks.

Carry out four simple steps, to download the updates needed and to keep your computer on the current status of technology:

1. Open **Windows Update** in the Help and Support Center.
2. Click on **Search for update**.
3. Click on **Add** to select the desired update and to add it to the updates to be installed, while you are searching through the available updates in each category. You can also read a complete description of each individual element by clicking on the **Read further** Link.
4. Click on **Check and install updates**, when you have selected all the desired updates, and then click on **Install now**.

## WINDOWS UPDATE INFORMATION FOR DATA SECURITY

Windows Update needs certain information about the respective notebook, so that a suitable list with updates can be provided for you. This information will include the following:

- Version number of the operating system
- Version number of Internet Explorer
- Version numbers of additional software programs
- Plug & Play identification key of the hardware devices

Windows Update will stand up for the protection of your private data and will not record your name, address, email address or other forms of personal data. The information collected will only be used during the time that you are visiting the website. It will also not be stored.

# SYSTEM RECOVERY

---

Windows<sup>xp</sup> provides a useful function enabling the storage of the so-called **Recovery points**.

The system remembers the current configuration as a snapshot and returns to this, if necessary. The advantage is that an unsuccessful installation can be cancelled.

**Recovery points** are created automatically by the system, but they can also be set manually.

You can determine and configure yourself the maximum memory taken up by this. You find this program in the program file under **accessories, system programs**.

We recommend setting a **recovery point** before installing a new software or driver. If the system does not run stable any longer this enables you usually to return to a workable configuration without deleting newly created documents. In the next paragraph read your options for a repair of an incorrect installation.

## CORRECTION

Windows<sup>xp</sup> includes various functions ensuring that the PC as well as the installed applications and devices work correctly.

These functions assist you in solving the problems which might occur by adding, deleting or replacing files required for the functionality of the operating system, the applications and devices. The recovery function or functions you use depend on the type of occurring problem or error. For detailed information refer to the Windows help.

Enter the search word “**Overview over the repair**” in order to evaluate which of the following functions is the safest way to correct your problem:

- Backup
- Recreation of device drivers
- Deactivation of the device
- System recreation
- Last configuration known to function
- Protected Mode and system recreation
- Recreation console
- Windows installation disk

## **SYSTEM RESTORE POWERED BY SYMANTEC**



If your system is not functioning properly and Windows XP System Restore did not solve the problem, then you should use the Application Support Disc to restore your system. This recovery mode provides several options.

## LIMITS OF THE RECOVERY

- Changes made to the original configuration (RAS, Desktop or Internet settings) and installed Software will be ignored by this Recovery and will not be reloaded.
- Driver Updates or hardware installed by you will be ignored by this Recovery.
- **Beware!** All data on drive C will be erased. If necessary, backup all required data on drive D. (You **must** pay attention to the information of pages 4 and 65).

This recovery will reset your system to its **condition at delivery**. Printer installations or other additional software must be reinstalled.

## PERFORMING THE RESTORE

1. First, please read the entire **Restore** section of the Windows Help file.
2. Insert the Support-CD and reboot the notebook.
3. Select the option „**Boot from CD-ROM**“.
4. Read the Licensing Conditions and then press the **Escape** key.
5. Agree to the Licensing Conditions with **Yes** and follow the instructions on the screen.
6. Select one of the options given to start system recreation.

The notebook will restart after each option selected.

## LOCALIZE THE CAUSE

Errors can have simple causes, but sometimes they are caused by faulty equipment. We would like to give you some tips to help solve common problems. Should these instructions not lead to success, please feel free to contact us.

### CHECK CABLES AND CONNECTIONS

Visibly check all cables and connections. Should all lights be off, check whether all equipment is supplied with power.

- In battery mode, connect the notebook to the power adapter and ensure that the battery is charged up.
- If you are operating the notebook with the power adapter, check the electrical socket, power cord and all switches in the circuit of the electrical socket.
- Switch off the notebook and check all cable connections. Check the connections to peripherals. Do not exchange cables, even though they may look similar. The polarity in the cables may be different. When it is confirmed that the notebook has power and all connections are correct, turn the notebook on again.

### THE POWER ON SELF TEST (POST)

The Power On Self Test (POST) is executed during each boot process to test the memory, motherboard, display, keyboard and other components. If the notebook does not pass the POST but beeps several times, or if the screen remains blank, call your notebook support technician.

## ERRORS AND POSSIBLE CAUSES

The screen is black:

- Make sure that the notebook is not swapping data and the **Fn+F12** key combination has not been operated.

The notebook switches itself off during operation.

- The accumulator could be empty. Connect the notebook by means of the network adapter and charge the accumulator.

The notebook cannot be switched on.

- Operate the notebook by means of the accumulator and check whether it is correctly inserted and charged.

Incorrect time and date display.

- Double click the time display in the task bar and set the correct values afterwards.

No data can be read from the optical drive.

- Check whether the disk is correctly inserted.
- Is the drive displayed in Explorer? If yes, test another disk.

The mouse or the touchpad is not functioning.

- Check the cable connection.

The **Fn+F2** key combination does not react.

- The second monitor is not activated under **Display Characteristics**. Select it by removing the tick from **Add this monitor to Windows Desktop** under **Settings**.

The WLAN connection is not functioning.

- You must press the relevant key combination **Fn+F1** to activate the WLAN connection, and the relevant indicator will light up.

## ADDITIONAL SUPPORT

If the suggestions in the above section have not solved your problem, please contact customer care and we will attempt to help you solve the problem. Before you call, however, please have the following information available:

- How is your computer configured?
- What additional peripherals do you use?
- What messages, if any, appear on your screen?
- What software were you using when the error occurred?
- What steps have you already undertaken to solve the problem?
- Have you upgraded or removed drivers or hardware?
- Can you manually repeat the problem?
- If you have been given a customer number previously, please have this available.

## DRIVER SUPPORT

This notebook has been extensively tested in our laboratories with a large number of compatible devices. It fulfils all required standards and complies with the standard "Designed for Windows", which certifies utmost compatibility. However, the software drivers for individual components are updated from time to time. This is a regular process provided by the manufacturer to mend possible compatibility problems that may occur with components (e.g., programs or hardware) that were not tested at the time of your notebook's manufacture.

# MAINTENANCE

---

⇒ **Warning!** There are no user-serviceable or user-cleanable parts inside the notebook housing. Never open the notebook housing.

Following these measures can extend the lifetime of your notebook:

- ☞ Before cleaning, always **remove** the power adapter plug and all connecting cables.
- ☞ Only use a damp, lint-free cloth to clean the notebook.
- ☞ **Do not** use any solvents, corrosive or gaseous cleaning agents .
- ☞ **Do not** use CD-ROM cleaning disks or similar products that clean the lens of the laser to clean your optical drive.
- ☞ Dust or grease on the touchpad will impair its sensitivity. Remove dust or grease on the surface of the Touchpad with a strip of sticky tape.

## CARE OF THE TFT DISPLAY

- ☞ Always close the notebook when not in use. Avoid touching or scratching the surface of the screen as it is easily damaged.
- ☞ Make sure that no water drops are allowed to remain on the screen. Water can cause permanent discoloration.
- ☞ Clean the screen with a dry, soft, lint-free cloth.
- ☞ Do not expose the screen to bright sunlight or ultraviolet radiation.
- ☞ The notebook and its packaging are recyclable.

## TRANSPORTING THE NOTEBOOK

Please use the following guidelines when transporting the notebook:

- ☞ Switch off the notebook. This will prevent damage to the hard disk. When the notebook is turned off, the hard disk heads are moved into a safe area.
- ☞ Wait until the PC has reached ambient (room) temperature before connecting it to the power supply. Drastic variations in temperature and humidity can create condensation within the PC and may cause it to **short-circuit**.
- ☞ Close the notebook and ensure that the cover locks shut.
- ☞ Always use the notebook carrying case. This helps to protect the notebook from dirt, moisture, jolts and scratches.
- ☞ Should you need to ship your notebook, always use the original packaging and make certain the shipper knows the contents contain fragile electronic equipment.
- ☞ Fully charge your battery and any spare batteries immediately before a long journey.
- ☞ Enquire about the electricity and communication provision at the location before a journey.
- ☞ Acquire the necessary adapter for electricity or communication (modem, LAN, etc.), if necessary, before starting your journey.
- ☞ Put the battery into the packaging separately when despatching the notebook.
- ☞ It is recommended to send the notebook and all magnetic storage media (floppy disks, external drives) through the x-ray device (the device into which you put your bags), when you are passing through the baggage check at airports. **Avoid the magnetic detector** (the construction, through which you walk) or the magnetic rod (the manual device of the security personnel), because they could destroy your data, among other consequences.

## RECYCLING AND DISPOSAL

This notebook and its packaging was produced mostly from materials which can be disposed of in an environmentally friendly manner and be professionally recycled.

After its use the computer will be taken back and recycled or use will be made of its useful material, if it is returned in a condition corresponding to its intended use.

Parts not usable will be properly disposed of.

⇒ **ATTENTION!** There is a lithium battery on the motherboard. No type of battery belongs in the household waste. All are taken back free of charge by the manufacturer, dealer or their representatives for a proper method of utilisation or disposal.

Should you have any questions concerning the disposal please contact your dealer or our service.

## BATTERIES AND PROPER TREATMENT

Batteries may contain combustible materials. By misuse, this may cause battery **leakage, heat, explosion or ignition**, bringing about **injury or damage** to the device. Please observe strictly the following matters:

⇒ **Attention:** There is a lithium battery on the motherboard. Lithium batteries are **hazardous waste** and need to be disposed of properly. If necessary, we will take back your used CMOS lithium battery.

- **KEEP CHILDREN AWAY** from batteries.  
If by any chance, the batteries are swallowed, consult a doctor immediately.
- **DO NOT CHARGE** batteries (except rechargeable batteries).
- **DO NOT FORCIBLY DISCHARGE** batteries.
- **DO NOT SHORT-CIRCUIT** batteries.
- **DO NOT HEAT** or **DISPOSE OFF IN FIRE.**
- **DO NOT DISASSEMBLE** or **DEFORM** batteries.  
Your hands and fingers may be injured, or the liquid of the battery may get into your eyes or adhere to your skin. If this happens, rinse with a large quantity of water immediately and consult a doctor.
- **DO NOT** expose batteries to **strong impact** by dropping or throwing the batteries.
- **DO NOT reverse** the positive (+) and negative (-) **terminals** to avoid short-circuit.
- **Do NOT MIX** used and new or different types of batteries together.  
Your equipment may not operate properly.  
In addition, the battery exhausted first may be excessively drained (over-discharged).
- **REMOVE PROMPTLY** the **used batteries** from the device.
- **REPLACE ALL BATTERIES** with new batteries of the same type at the same time.
- **INSULATE THE TERMINAL** parts with tape or the like at the **storage or disposal** of the batteries.
- **DO NOT throw** rundown batteries in the domestic refuses! Respect the environment and throw them in the specific containers for separate collection. If necessary, turn to your reseller or to our service assistance. Thank you!

# SECURING YOUR NOTEBOOK

## SETTING A USER PASSWORD

You can prevent unauthorized access to your notebook by setting a User Password. When starting the notebook the password will be requested. The User Password is set in the **BIOS**.

⇒ **Attention:** Keep your password in safety place. If you forget your password you do not have the possibility to cancel it. In this case please call your service centre.

To protect your data from unauthorized access, you can also use the security option of Windows<sup>XP</sup>. See also chapter „Data and System Security“ (⇒ p. 65).

## USING A SAFETY LOCK

You can prevent theft by using a so called **Kensington-lock**, which can be bought at your local retailer.

The cable wraps around an object and the „T“ shaped end inserts into the Kensington lock port and a key or combination dial is used to secure the lock in place. Please keep your key at a safety place.

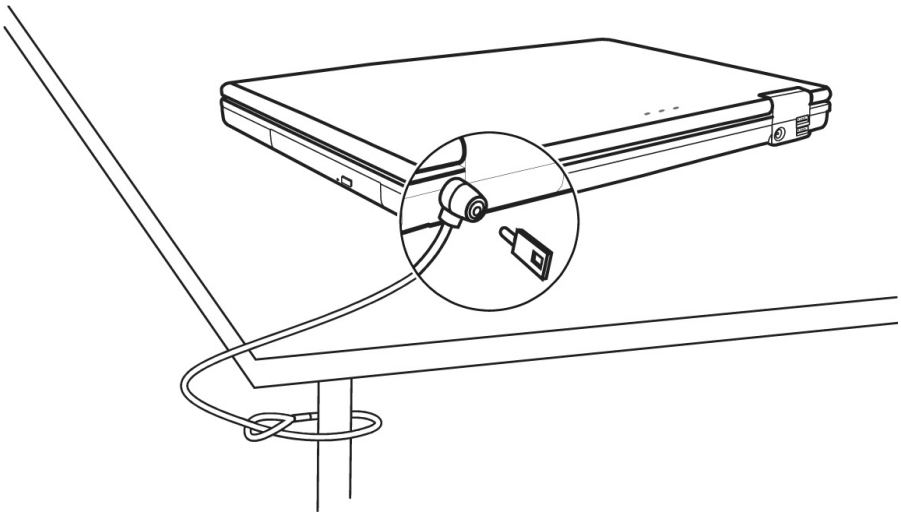

## UPGRADES AND REPAIRS

- Only a qualified Service Engineer should perform upgrades and repairs to your notebook.
- If you do not have the necessary qualifications, go to an appropriate **Service Engineer**. Please contact the **Service Centre** if you are experiencing technical problems with your notebook.
- Please contact our authorized **Service Partners** exclusively in the case of a necessary repair.

## NOTES FOR SERVICE ENGINEERS

- Before opening the housing, disconnect the notebook from all power sources and remove any connecting cables. If the notebook has not been disconnected from the power outlet before being opened, there is a **danger** of severe electric shock. There is also a risk of damage to the components.
- Internal components of the notebook may be damaged by **electrostatic discharge** (ESD). Perform system upgrades and changes in an **ESD-protected work area**. If no such work area is available, wear an **antistatic wrist strap** or touch a highly conductive metal object. Your service center can repair damage sustained by inappropriate handling for a fee.
- Use only **original spare parts**.

**CAUTION:** The CMOS lithium batteries cannot tolerate intense pressure, high temperatures or fire. Keep away from children! Danger of explosion if replaced incorrectly. Only replace with a compatible type (CR2032) as recommended by the manufacturer. Lithium-Batteries are **hazardous waste** and need to be disposed of properly. If necessary, we will take back your used CMOS lithium battery.

### **Notes on Laser Radiation :**

Laser devices of Laser Class 1 to Laser Class 3b may be used in the notebook. Where the notebook housing remains closed, the device meets the requirements of **Laser Class 1**. By opening the notebook housing you will gain access to laser devices of up to Laser Class 3b.

- The CD-ROM/CD-RW/DVD/DVD-RW drive contains no user-serviceable parts. Only the **manufacturer** should perform repairs to the CD-ROM/CD-RW/DVD/DVD-RW drives.

When removing and/or opening laser devices, the following guidelines must be observed:

- **DO NOT** look into the laser beam, even while wearing optical protection.
- **DO NOT** allow yourself to be exposed to the laser beam. Avoid exposure of the eyes or skin to direct or stray radiation.

# Appendix

<b>Subject</b>	<b>Page</b>
Standards .....	83
Warranty .....	86
Index .....	89



## ELECTROMAGNETIC COMPATIBILITY

- When connecting additional components, please observe the *Guidelines on Electromagnetic Compatibility (EMC)*. Please note that only **shielded** cables shorter than 3 meters (9.84 ft) should be used for the LPT, COM, USB, IEEE 1394, audio, video and network interfaces with this notebook.
- Keep the notebook at least one meter (approximately three feet) away from **high frequency** and **magnetic interference sources** (e.g., televisions, loudspeaker cabinets, mobile telephones, etc.) in order to avoid malfunctions and/or loss of data.

## ISO 13406-2 CLASS II

Active matrix LCDs (TFT) with a resolution of 1024 x 768 pixel (XGA), which are in turn composed of three sub-pixels each (red, green, blue), contain about 2.4 million addressable transistors. Because of this very high number of transistors and their extremely complex production process occasionally defective or incorrectly addressed pixels or sub-pixels may occur.

There have been several attempts in the past to define the acceptable number of defective pixels. But this can be difficult and varies widely between different manufacturers.

We, therefore, adhere to the clear and strict requirements of **ISO 13406-2, class II**, for the warranty handling of all TFT display products. These requirements are summarized below.

Within ISO-standard 13406-2 the general requirements regarding pixel defects are defined. Pixel defects are classified into three failure types and four failure classes. Each individual pixel is made up of three sub-pixels in the primary colours (red, green, blue).

## Pixelstructure

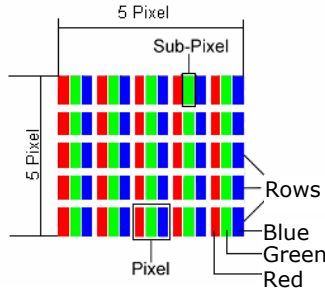

### Types of Pixel Failures:

- Type 1: A constantly lit pixel (a bright, white spot), even though it is *not* addressed  
A white pixel is caused when all three sub-pixel are lit.
- Type 2: A pixel that does not light up (dark, black spot), although it is addressed
- Type 3: Abnormal or defective red, green or blue sub-pixels.  
(E.g. constantly lit with half the brightness, one colour is not shining, blinking or flickering, but not belonging to Type 1 or 2 Pixel Failures)

In addition: A cluster of type 3 (= 2 or more defective sub-pixels in an array of 5 x 5 pixel). A cluster is an array of 5 x 5 pixel (15 x 5 sub-pixel).

### ISO 13406-2, Class II

<u>Resolution</u>	<u>Type 1</u>	<u>Type 2</u>	<u>Type 3</u>	<u>Cluster Type 1, Type 2</u>	<u>Cluster Type 3</u>
1024 x 768	2	2	4	0	2
1280 x 854	3	3	6	0	3
1280 x 1024	3	3	7	0	3
1400 x 1050	3	3	8	0	3

### Example:

A 17" - SXGA-display consists of 1280 horizontal and 1024 vertical picture dots (pixel), which amounts to a total of 1,31 million pixels. Based on one million pixels this translates into a factor of about 1.31.

Class II type failure consequently allows for three defects each of type 1 and type 2 and 7 defects of type 3 and 3 cluster of type 3.

These cases are normally not covered by warranty.

If the number of failures exceeds the figures of any category mentioned above then this may be covered by the warranty.

## FCC COMPLIANCE STATEMENT

This equipment has been tested and found to comply with the limits for a Class B digital device, pursuant to Part 15 of FCC Rules. These limits are designed to provide reasonable protection against harmful interference in a residential installation. This equipment generates, uses, and can radiate radio frequency energy and, if not installed and used in accordance with the instructions, may cause harmful interference to radio communications. However, there is no guarantee that interference will not occur in a particular installation. If this equipment does cause harmful interference to radio or television reception, which can be determined by turning the equipment off and on, the user is encouraged to try to correct the interference by one or more of the following measures:

- Reorient or relocate the receiving antenna.
- Increase the separation between the equipment and receiver.
- Connect the equipment into an outlet on a circuit different from that to which the receiver is connected.
- Consult the dealer or an experienced technician for help.

Changes or modifications not expressly approved by the party responsible for compliance could void the user's authority to operate the equipment. Shielded interface cables, if any, must be used in order to comply with the emission limits.

## WARRANTY

---

The receipt serves as proof of first purchase and should be kept in a safe place. Your legal rights **are not limited** by these warranty conditions. It is required should you need to make use of the guarantee.

We guarantee that this equipment is in perfect working order. Upon production of the receipt, the remaining period of guarantee shall pass on from the original parts to the respective replacement parts. If you hand in this equipment to make use of the guarantee, you must remove all programs, data and removable storage media. Products which are sent without accessories will be replaced without accessories. The warranty obligation does not apply in the case of the problem being caused by an accident, a catastrophe, vandalism, misuse, incorrect use, ignoring the safety and maintenance regulations, changes by software, viruses or another piece of equipment or accessories or by other modifications not approved by ourselves. This limited guarantee declaration replaces all other guarantees of express or implied nature. This includes the guarantee of saleability or the suitability for a certain purpose but is not limited to this. In some countries the exclusion of implied guarantees is not permissible upon principle. In this case the validity of all express and implied guarantees is limited to the guarantee period. Once this period has expired, all guarantees become invalid. In some countries limiting the period of validity for implied guarantees is not permitted, so that the above limitation does not come into force. If you have any questions with regard to these guarantee conditions, please contact us.

## LIABILITY LIMITATIONS

The contents of this manual are subject to unannounced changes caused by technical progress. Manufacturer and sales shall not be responsible for any damages which have been caused as a result of omissions or errors in the information provided in this manual.

Under no circumstances shall we be liable for any of the following:

1. Claims made against you by third parties based on loss or damage.
2. Loss or damage to your blanks, recordings or data.
3. Economic follow-on damage (including lost profit or savings) or associated damage even in the case that we have been informed of the possibilities of this type of damage.

In some countries the exclusion or limitation of accompanying or follow-on damage is not legally accepted so that the above limitations do not come into force.

## COPYING THIS MANUAL

This document contains legally protected information. All rights reserved. Copying in mechanical, electronic and any other form without the written approval of the manufacturer is prohibited.



# INDEX

---

---

## A

All programs .....	20
Ambient Temperature .....	5
Audience .....	ii
Audio Out.....	13, 45
Autorun .....	58

---

## B

Batteries and Proper Treatment .....	77
Battery operation	
Battery Power .....	29
Checking the Battery Level .....	29
Battery Operation.....	8, 27
Charging .....	28
Discharging the Battery.....	28
Removing.....	27
Battery Power .....	29
BIOS Setup-Program .....	60
BIOS Utility	
Navigating.....	60
Running .....	60

---

## C

Cabling .....	6
Care of Displays .....	74
CD/DVD-Rewriter .....	44
CD-blanks .....	44
CD-ROM.....	40
Charging the Battery.....	28
Checking the Battery Level ....	29
Clone Desktop .....	33
Connectors	
External Monitor.....	33
IEEE 1394 .....	54
Modem .....	47

PC Card .....	52
Sound card .....	45
TV .....	35
USB .....	53
Control panel.....	20
Copyright® .....	ii
Correction.....	68

---

## D

Data and System Security .....	65
Data Entry .....	36
Data Security .....	4, 65
Directories .....	39
Disc-Drive.....	40
Discharging the battery.....	28
Discs	
Loading .....	40
Removing Blocked Discs.....	42
Display .....	31
Opening and Closing the	
Display .....	31
Display catch.....	13
Driver Support.....	73
Drivers .....	39
DVD-Drive .....	40

---

## E

Electromagnetic Compatibility	83
EMC .....	83
Emergency Ejection of a Blocked	
Disc .....	42
Extend Desktop .....	34
External monitor .....	13
External Monitor .....	33
Clone Desktop .....	33
Extend Desktop .....	34
Externe Audioverbindungen ...	45

---

**F**

Factory Settings	
Recovery.....	69
FAQ.....	63
Fast Ethernet-Network .....	49
FCC Compliance Statement....	85
Files	
Finding .....	38
Finding Files .....	38
Fn.....	36
Frequently Asked Questions ...	63

---

**G**

Getting Started .....	16
-----------------------	----

---

**H**

Hard drive.....	38
Hard Drive	
Partitions .....	38
help .....	55

---

**I**

Icons.....	20
IEEE 1394 .....	13
Indicators	
AC power .....	14
Access .....	15
Access optical drive .....	15
Battery charge.....	14
Battery power.....	14
Capital Lock.....	15
Num Lock.....	15
Scroll Lock .....	15
Wireless LAN .....	15
Information about the regulatory compliance of wireless Lan...	7
Installing a PC Card .....	52
Introduction .....	3
ISO 13406-2 Class II .....	83

---

**K**

Kensington lock .....	14
Kensington-lock .....	78
Keyboard .....	36

---

**L**

LAN port (RJ-45 .....	13
Laser radiation .....	80
License agreement .....	18

---

**M**

M microphone In .....	45
Main components.....	23
Main Operation .....	26
Maintenance.....	74
Care of the TFT Display.....	74
Transporting the Notebook .	75
Maintenance Programs.....	65
Microphone In .....	13
Modem .....	47
Modem Port .....	48
Modem port (RJ-11) .....	13
Mouse .....	37

---

**N**

Network .....	49
Fast Ethernet-Network.....	49
Troubleshooting.....	50
What is a Network? .....	49
Wireless LAN .....	51

---

**O**

On/Off Button.....	25
Optical Drive .....	13

---

**P**

Partitions .....	38
Password Reset Disk .....	65
PC Card	
Installing.....	52
Removing.....	52
PC Card Slot .....	52
Performing the Restore .....	70
POST .....	71
Power	
Turning off your computer ..	20
Power Management .....	30
Power On Self Test .....	71
Power supply .....	6
Power Supply.....	25
Battery Operation.....	27
Main Operation .....	26
Standby Mode.....	30
Suspend Mode .....	30
Program bar .....	19
Programs	
Location.....	39

---

**Q**

Quality.....	ii
--------------	----

---

**R**

Recover .....	39
Recovery.....	68
Factory Settings.....	69
Recycling and Disposal .....	76
Reinigungsmittel .....	74
Removing a PC Card .....	52
Removing the Battery .....	27
Repairs .....	79
Restoring	
Limits .....	70
Running the Bios Setup .....	60

---

**S**

Safety and maintenance.....	1
Safety Instructions.....	3
Ambient Temperature.....	5
Battery Operation .....	8
Cabling.....	6
Data Security .....	4
Modem .....	7
Power supply.....	6
Set-Up location.....	5
Touch Pad.....	7
Upgrades and Repairs.....	79
Screen Resolution .....	32
Search .....	38
Securing your Notebook.....	78
Serial Number .....	ii
Service Engineers .....	79
Setting a User Password .....	78
Set-Up Location .....	5
Software.....	55
Deinstallation .....	59
Installation .....	57
Windows Activation .....	59
Sound card .....	45
External audio ports .....	45
Standards .....	83
Electromagnetic	
Compatibility.....	83
FCC Compliance Statement	85
Standby Mode .....	30
Start button .....	19
Support .....	73
Surround sound system .....	46
Suspend to Disk.....	30
System Recovery	
Correction.....	68

---

**T**

Table of Contents.....	vi
Task bar .....	20
Touch Pad.....	7, 37
Trademarks.....	ii
Transport.....	75

Troubleshooting .....	71
Errors and Possible Causes .....	72
Turn off computer .....	20

---

**U**

Universal Serial Bus .....	53
Upgrades and Repairs .....	79
USB port .....	13
Using a Safety Lock .....	78

---

**V**

Video out s-video .....	13
Views	
AC power indicator .....	12
Audio Out.....	13
Battery charge indicator .....	12
Battery power indicator .....	12
Device indicator .....	14
Device indicators .....	12
Display catch .....	13
IEEE 1394 .....	13
Kensington lock.....	14
LAN port (RJ-45) .....	13
Left side.....	13

Microphone In .....	13
Modem port (RJ-11) .....	13
Monitor (external).....	13
Optical drive.....	13
PC card slot PCMCIA.....	13
Power ON/OFF button .....	12
Stereo speaker set.....	12
TFT Display .....	12
USB port.....	13
Video out s-video .....	13

---

**W**

Warranty .....	86
Windows XP	
Control Panel.....	20
help .....	55
Help.....	20
Help and Support.....	55
Interactive Training .....	56
Manual .....	55
Windows® Desktop .....	19
Windows® Update .....	66
Wireless LAN .....	51
Working in Comfort .....	21